



# Creator 3

金 刚 狼 三 代

U S E R G U I D E

用户 使用 手册

SZ20-CN/EN-A02

中文P50



This guide is only applicable to FLASHFORGE Creator 3 3D printer

本手册仅适用于闪铸科技 Creator 3 3D打印机

## PREFACE

**Note:** Each device must be tested before leaving factory. If there are some residues in extruder or some tiny scratches on the build tape, it is normal and won't affect the printing quality.

On the completion of this User Guide, thanks all FlashForge engineers and the FlashForge 3D printer users for their unremitting efforts and sincere assistance.

The FlashForge Creator 3 User Guide is designed for the Creator 3 users to start their printing journey with FlashForge Creator 3. Even if you are familiar with earlier FlashForge machines or 3D printing technology, we still recommend that please read this guide, as there is lots of important information about the Creator3 for you to get a better 3D experience.

For a better and more successful printing experience, you can refer to the following materials:

**(1) User Guide:**

Users will find the User Guide together with the printer accessories. The User Guide will help you start your print journey as soon as possible.

**(2) Official FlashForge Website:**

FlashForge Chinese website: [www.sz3dp.com](http://www.sz3dp.com)

FlashForge English website: [www.flashforge.com](http://www.flashforge.com)

The official FlashForge website contains the up-to-date information concerning FlashForge software, firmware, device maintenance and so on. Users are also able to get the contact information from there.

## NOTICE

**PLEASE STRICTLY FOLLOW ALL THE SAFETY WARNINGS AND NOTICE BELOW ALL THE TIME.**

### WORK ENVIRONMENT SAFETY

- ◆ Keep your work place tidy.
- ◆ Do not operate Creator 3 in the presence of flammable liquids, gases or dust.
- ◆ Keep Creator3 out of children and untrained persons' reach.

### ELECTRICAL SAFETY

- ◆ Always use the Creator3 with a properly grounded outlet. Do not refit Creator3 plug.
- ◆ Do not use Creator3 in damp or wet locations. Do not expose Creator3 to burning sun.
- ◆ In case of device damage, please use the power supply provided by FlashForge.
- ◆ Avoid using the device during an thunderstorm.
- ◆ In case of uncertain accident, please unplug the device if you do not use it for long.

### PERSONAL SAFETY

- ◆ Do not touch the nozzle and build plate during printing.
- ◆ Do not touch the nozzle after finishing printing.
- ◆ Dress properly. Do not wear loose clothing or jewelry. Keep your hair, clothing and gloves away from moving parts.
- ◆ Do not operate the device while you are tired or under the influence of drugs, alcohol or medication.

## CAUTIONS

- ◆ Do not leave the device unattended for long.
- ◆ Do not make any modifications to the device.
- ◆ To lower the build plate before loading/unloading filament. (The distance between the nozzle and build plate should be kept for at least 50mm)
- ◆ Operate the device in a well-ventilated environment.
- ◆ Never use the device for illegal activities.
- ◆ Never use the device to make any food storage vessels.
- ◆ Never use the device to make any electrical appliance.
- ◆ Never put the model into your mouth.
- ◆ Do not remove the models with force.
- ◆ Never connect the device with network cable longer than 3m.

## ENVIRONMENT REQUIREMENTS

- ◆ Temperature: RT 15-30°C
- ◆ Moisture: 20%-70%

## PLACE REQUIREMENTS

- ◆ The device must be placed in a dry and ventilated environment. The distances of the left, right and back side space should be at least 20cm, and the distance of the front side space should be at least 35cm.

## FILAMENT REQUIREMENTS

- ◆ Do not abuse the filament. Please make sure you use the FlashForge filament or the filament from the brands accepted by FlashForge.

## FILAMENT STORAGE

- ◆ All polymers degrade with time. Do not unpack until filament is needed. Filament should be stored at clean and dry conditions.

## LEGAL NOTICE

- ◆ All the information in this document is subject to any amendment or change without the official authorization from FlashForge.
- ◆ FLASHFORGE CORPORATION MAKES NO WARRANTY OF ANY KIND WITH REGARD TO THIS DOCUMENT, INCLUDING, BUT NOT LIMITED TO, THE IMPLIED WARRANTIES OF MERCHANTABILITY AND FITNESS FOR A PARTICULAR PURPOSE.
- ◆ FlashForge shall not be liable for errors contained herein for incidental consequential damages in connection with furnishing, performance or use of this material.
- ◆ Flashforge reserves the right to modify the User guide due to subsequent equipment updates.
- ◆ Copyright © 2019 FlashForge Corp. All Rights Reserved

## FCC STATEMENT

- ◆ This device complies with Part 15 of the FCC Rules. Operation is subject to the following two conditions:
  - (1) This device may not cause harmful interference,
  - (2) This device must accept any interference received, including interference that may cause undesired operation.
- ◆ Warning: Changes or modifications not expressly approved by the party responsible for compliance could void the user's authority to operate the equipment.
- ◆ This equipment has been tested and found to comply with the limits for a Class B digital device, pursuant to Part 15 of the FCC Rules. These limits are designed to provide reasonable protection against harmful interference in a residential installation. This equipment generates uses and can radiate radio frequency energy and, if not installed and used in accordance with the instructions, may cause harmful interference to radio communications. However, there is no guarantee that interference will not occur in a particular installation. If this equipment does cause harmful interference to radio or television reception, which can be determined by turning the equipment off and on, the user is encouraged to try to correct the interference by one or more of the following measures:
  - Reorient or relocate the receiving antenna.
  - Increase the separation between the equipment and receiver.
  - Connect the equipment into an outlet on a circuit different from that to which the receiver is connected.
  - Consult the dealer or an experienced radio/TV technician for help.
- ◆ This document contains proprietary information protected by copyright.

## SERVICE

- ◆ Always unplug Creator3 from its power before performing any service procedures. Failure to do so may result in personal injury and equipment damage.
- ◆ Use only Creator 3 approved materials and components. Use of object materials, or 3D objects other than FlashForge approved object materials and genuine FlashForge components may void warranty.

# CONTENT

<b>1. Introduction</b> .....	05
1.1 About Creator3	05
1.2 Accessories	06
1.3 Product Parameters	07
1.4 Terms	08
<b>2. Unpacking and Hardware Assembly</b> .....	09
2.1 Unpacking	09
2.2 Hardware Assembly	12
<b>3. First Installation</b> .....	13
3.1 Leveling	13
3.2 Filament Installation	15
3.3 Loading and Unloading	17
3.4 Calibration	19
3.5 Internet Connection	22
3.6 Flashforge Software	23
3.6.1 Software Installation	23
3.6.2 Software Interface	23
3.6.3 Set Dual Extruder Print	24
<b>4. Operation</b> .....	28
4.1 Filament	28
4.1.1 Filament Compatibility	28
4.1.2 Print Setting	28
4.2 Print Start-up	29
4.3 Model Removal	32
4.4 Support Removal	32
4.5 Camera Connection	33
<b>5. Introduction of Touch Screen</b> .....	36
5.1 Print	36
5.2 Preheat	38
5.3 Tools	39
<b>6. Maintenance</b> .....	47
6.1 Log Copy	47
6.2 Maintenance and Service	47
6.3 Extruder Unclogging	48
6.4 Daily Maintenance and Use Suggestion	48
<b>7. Support and Service</b> .....	49

# 1. Introduction

## 1.1 About Creator 3

### Device View

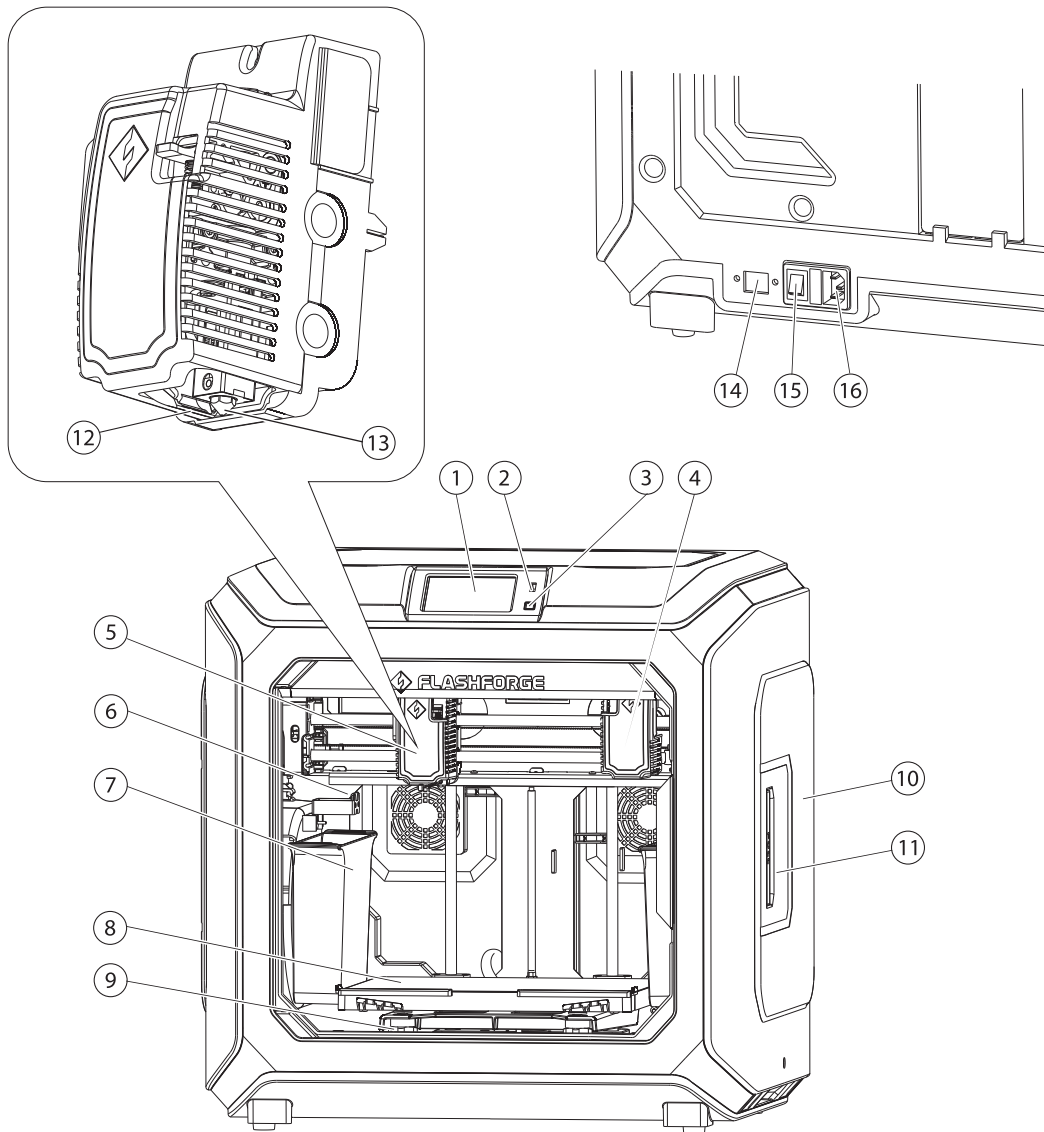

- 1. Touch screen
- 2. USB stick input
- 3. Touch screen button
- 4. Right extruder

- 5. Left extruder
- 6. Nozzle brush
- 7. Waste box
- 8. Build plate

- 9. Leveling nut
- 10. Filament cover
- 11. Filament cover handle
- 12. Wind guide nose

- 13. Nozzle
- 14. Ethernet Input
- 15. Power switch
- 16. Power input

## 1.2 Accessories

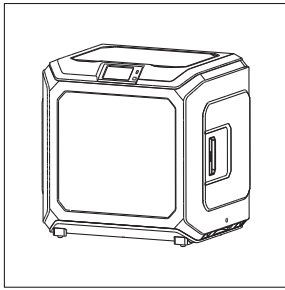

**Creator 3**

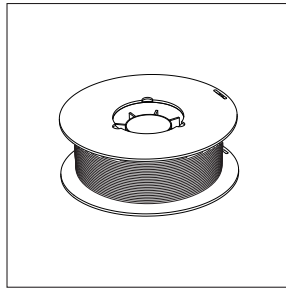

**Filament**

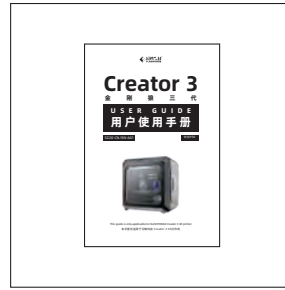

**User Guide**



**After-sales Card**

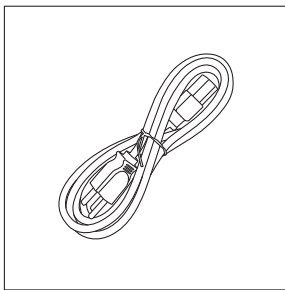

**Power cable**

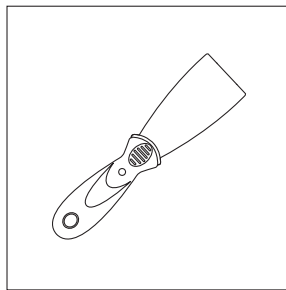

**Scraper**

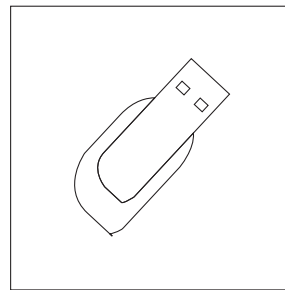

**USB Stick**

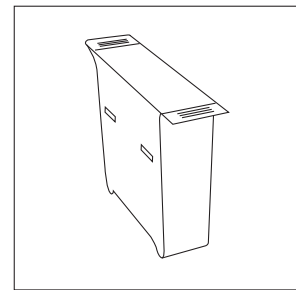

**Waste box**

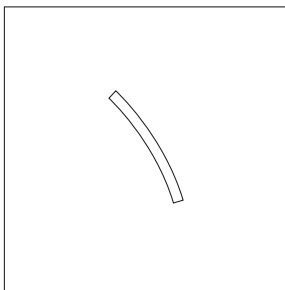

**PTFE Tube**

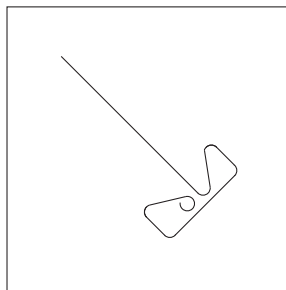

**Unclogging Pin Tool**

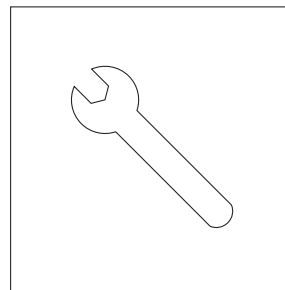

**Stamping wrench**

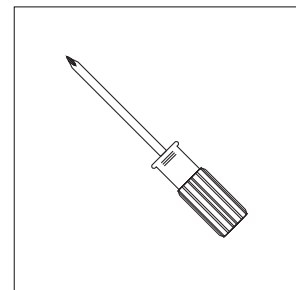

**Screw driver**

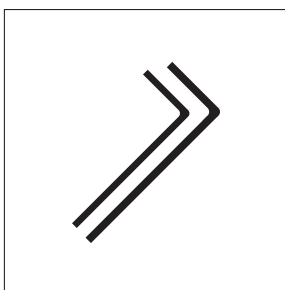

**Allen wrench**

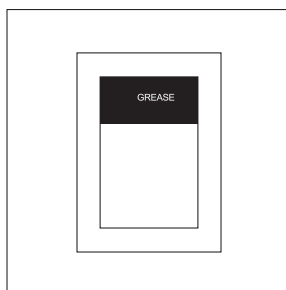

**Grease**

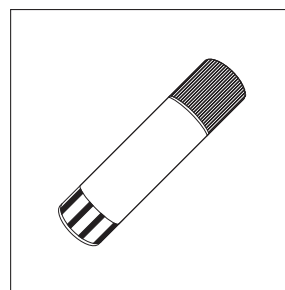

**Glue stick**

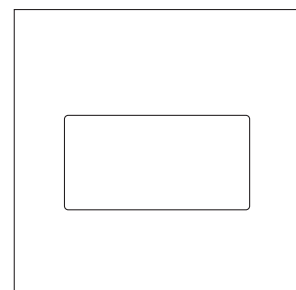

**Silicone brush**

## 1.3 Product Parameters

<b>Name</b>	Creator 3
<b>Number of Extruder</b>	2, independent
<b>Print Technology</b>	Fused Filament Fabrication(FFF)
<b>Screen Size</b>	4.5" color IPS Touch Screen
<b>Build Volume</b>	300×250×200mm
<b>Layer Resolution</b>	0.05 - 0.4mm
<b>Build Accuracy</b>	±0.2mm
<b>Positioning Accuracy</b>	Z axis 0.0025mm; XY axis 0.011mm
<b>Print Filament</b>	PLA/ABS/PC/PVA/HIPS/PETG/wood filament/Nylon
<b>Filament Diameter</b>	1.75mm (±0.07mm)
<b>Nozzle Diameter</b>	0.4mm
<b>Print Speed</b>	10~150 mm/s
<b>Travel speed</b>	10~150 mm/s
<b>Software</b>	FlashPrint
<b>Support Format</b>	Input: 3MF/STL/OBJ/FPP/BMP/PNG/JPG/JPEG Output: GX/G
<b>Operation system</b>	Win XP/Vista/7/8/10、 Mac OS、 Linux
<b>Device Size</b>	627×485×615mm
<b>Net Weight</b>	40Kg
<b>AC Input</b>	Input: 100V-240VAC, 47-63Hz Power: 500W
<b>Connectivity</b>	USB Stick, Wi-Fi, Ethernet,



## 1.4 Terms

<b>Build Plate</b>	The surface on which the Creator3 builds an object.
<b>Build Tape</b>	The blue tape that covers Creator3's build plate so that the object can stick to the build plate well.
<b>Build Volume</b>	The three dimensional amount of space that an object will use once it is completed. The largest build volume of Creator3 is 300*250*200 mm.
<b>Leveling Nuts</b>	Nuts under the build platform that are used for adjusting the distance between the nozzle and build plate.
<b>Extruder</b>	The device that draws the filament from the spool, melts it and pushes it through a nozzle into the build plate.
<b>Nozzle</b>	Also called "print head" , which located at the bottom of the extruder where heated filament is squeezed out.
<b>Nozzle fan</b>	Used to lower extruder temperature and speed up filament solidification.
<b>Filament Intake</b>	An opening located at the top of the extruder.
<b>Filament Cartridge</b>	A specific box for placing FlashForge filament.
<b>Filament Guide Tube</b>	A plastic piece that guides the filament from the filament box to the filament intake.
<b>Glue Stick</b>	A solid adhesive used for making the model stick to the build plate firmly.
<b>Unclogging Pin Tool</b>	A tool that used for cleaning and unclogging the extruder.
<b>Stamping Wrench</b>	A tool that used for seizing the nozzle's metal cube.
<b>Nozzle brush</b>	Used to clean extruder waste.

# 2. Unpacking and Hardware Assembly

## 2.1 Unpacking



1. Cut off packaging ties, and tear off stretch wrap.



2. Lift outer packing box.



3. Remove top foam.

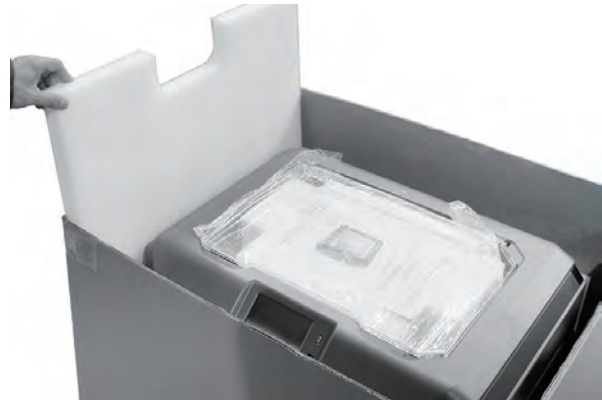

4. Remove foam around the printer.



5. Unrip tapes on four corners of the printer, take bubble pack down.



6. Remove tapes on the top, open head cover.



7. Take top parts and foam out.



8. Remove the blue fastening tape.



9. Open the front door and take out the front foam which should contain two filament spools and two waste boxes.

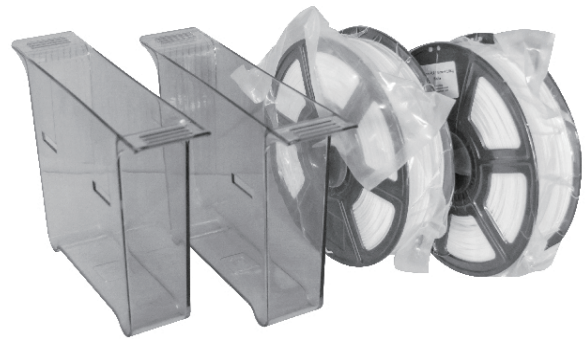

10. Remove clips on timing belt of X axis and Y axis.



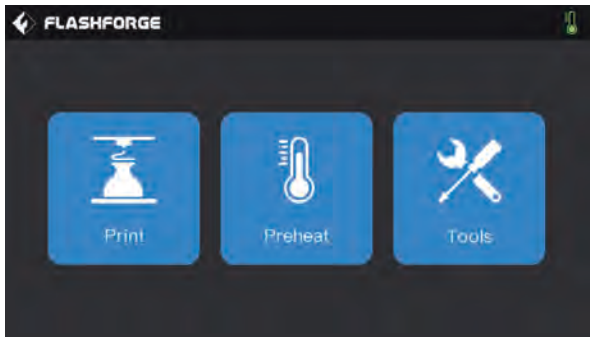

11. Insert power cable into power input of the printer back ,turn the power on.After that, tap[Tools]-[Manual] in turns to operate interface.

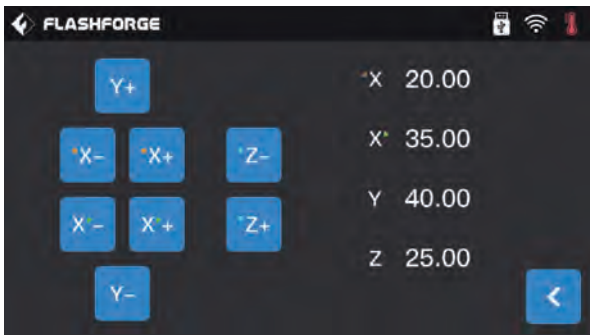

12. Tap[Z-]continuously until build plate rises to a high position ,thus taking out foam below easily.



13. Remove foam pieces under build plate.



14. Unboxing completed!Suggest to keep your accessories well for further use and transportation.

## 2.2 Hardware Assembly

### Install Waste box

Take out waste box, hang it on the hookbeside build plate.  
(One waste box on each side)

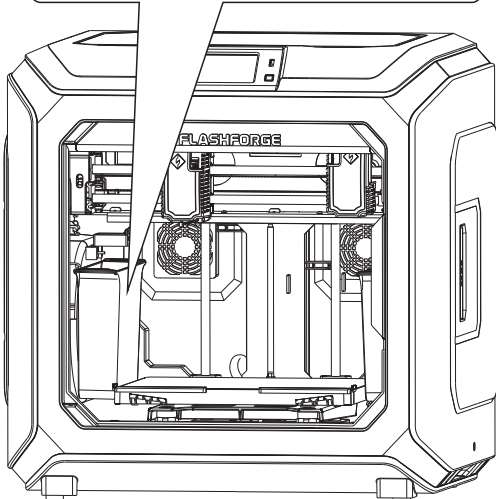
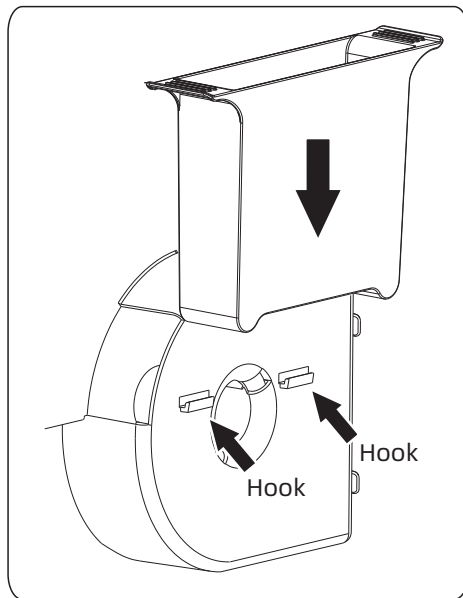
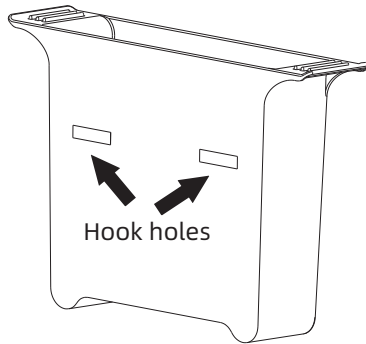

### Install Nozzle brush

Take out nozzle brush, install it on mounting base.  
(One nozzle brush on each side)

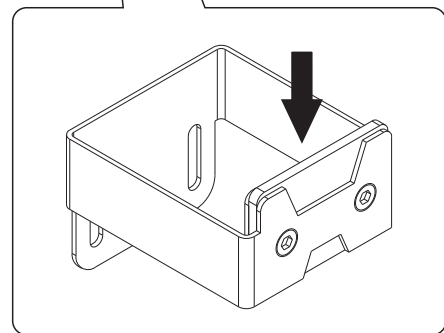
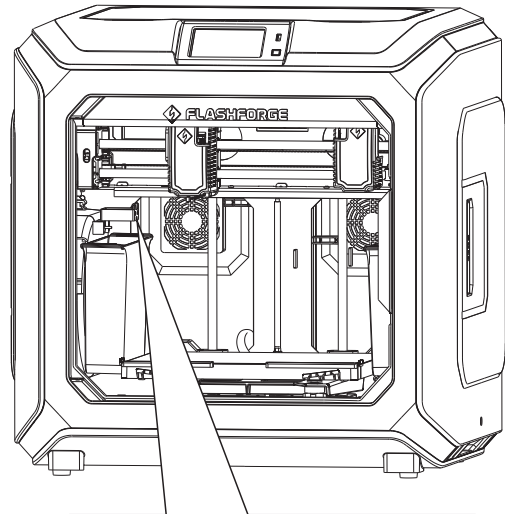

# 3. First Installation

## 3.1 Leveling

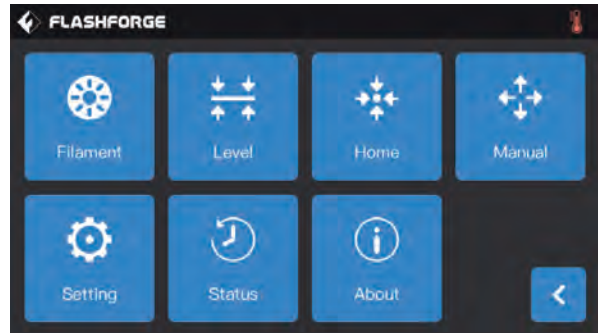
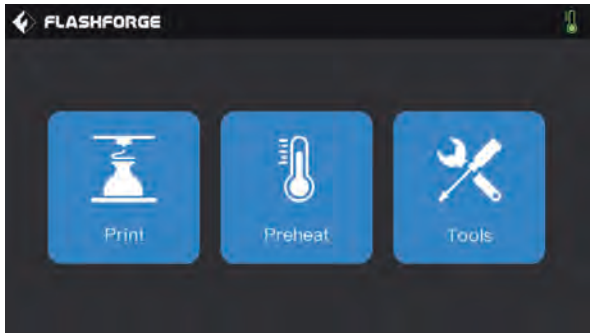

1、 Tap[Tools]-[Level] in turns on the touch screen, leveling starts.

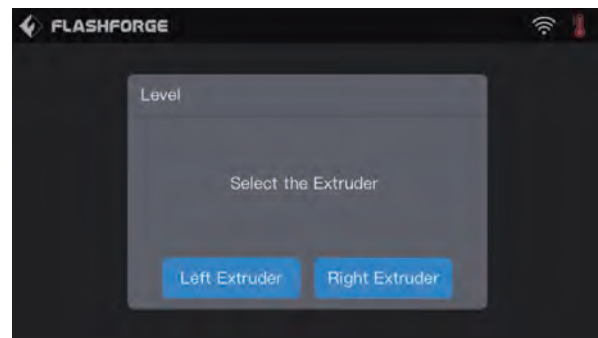
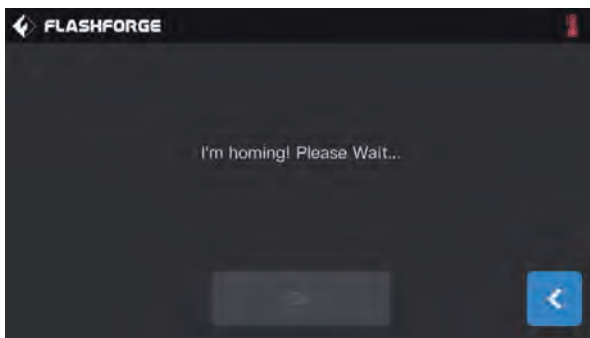

2、 After extruder and build plate stop moving,choose left/right extruder to do the leveling.

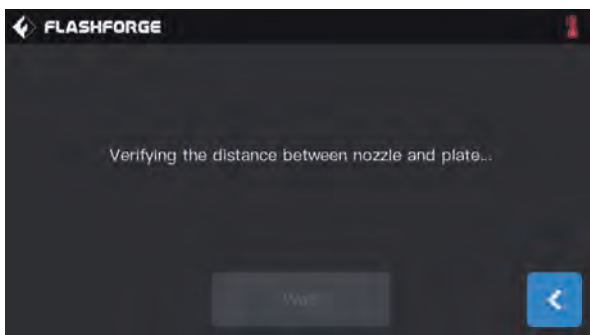

3、 After choosing completed, extruder moves to the first point to do the verify distance between nozzle and plate.After verifying completed,extruder moves to the second point to do the leveling.

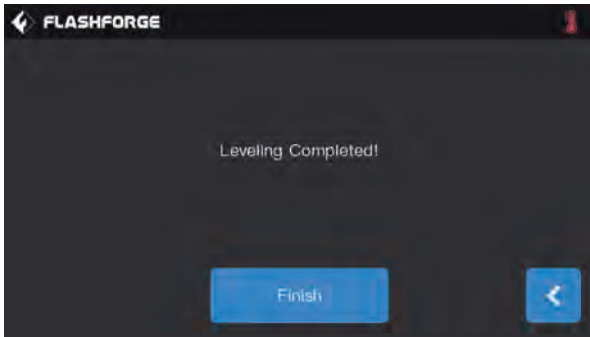
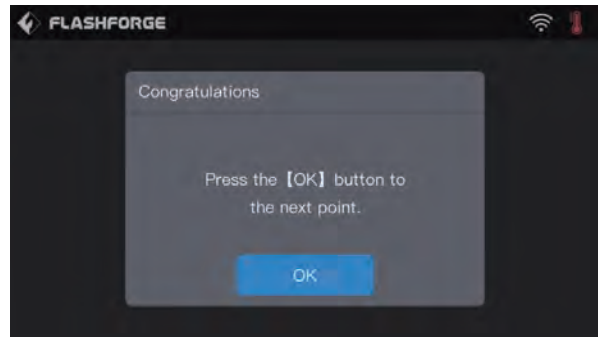

4. Wait for the extruder verifying distance between nozzle and plate on the second point and third point. If the distance between nozzle and plate is not appropriate, operate according to the instruction on the touch screen. After verifying completed, extruder moves to the third point, repeat the above steps to verify the distance as well. After finishing the third point, leveling completed.

**Note:** If leveling failed tip shown up on the touch screen, please repeat the leveling operation according to instructions until leveling finished.

## 3.2 Filament Installation

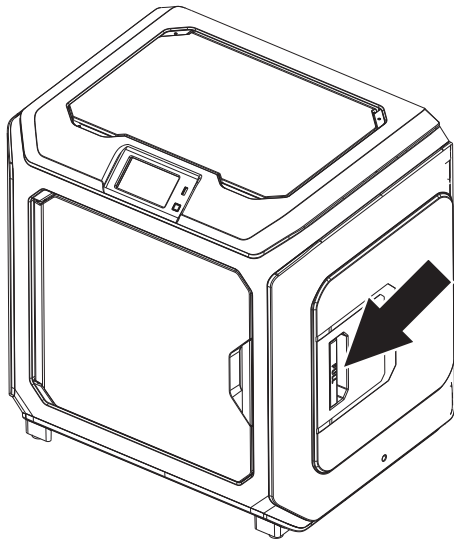

1. Open the filament cover.

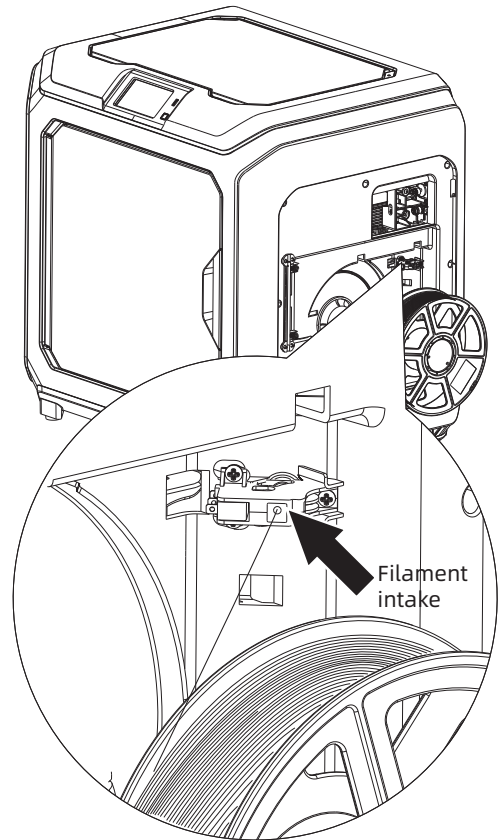

2. Insert the filament into filament intake.

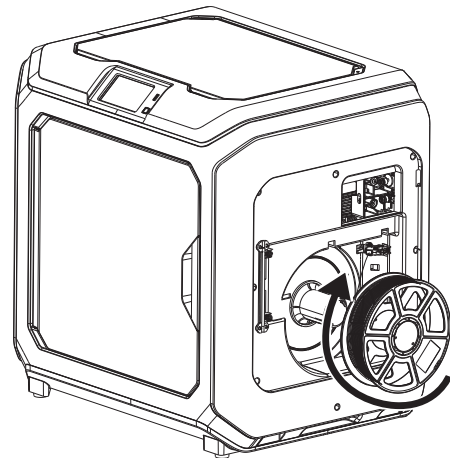
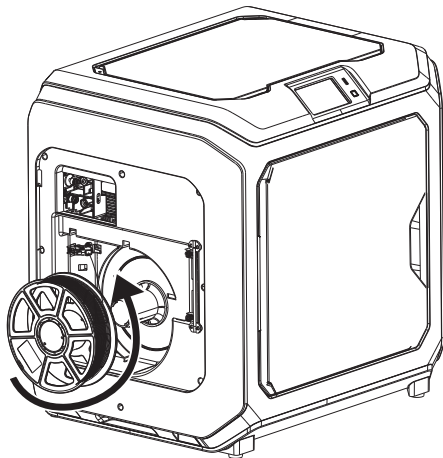

3. Notice: For filament convenient rotation, please install filament follow the direction shown in the picture.

**When installing filament on the left side, please unload filament anticlockwise;  
when installing filament on the right side, please unload filament clockwise.**



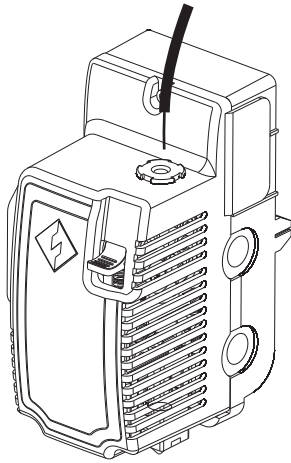

4. Insert filament into filament intake continuously until filament goes through filament guidetube.

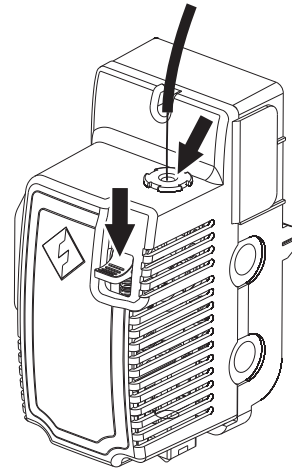

5. Press the spring presser, put filament vertically into the left filament intake to the bottom.

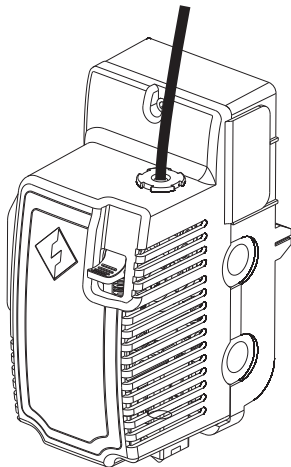

6. Insert filament guidetube into filament intake to fix.

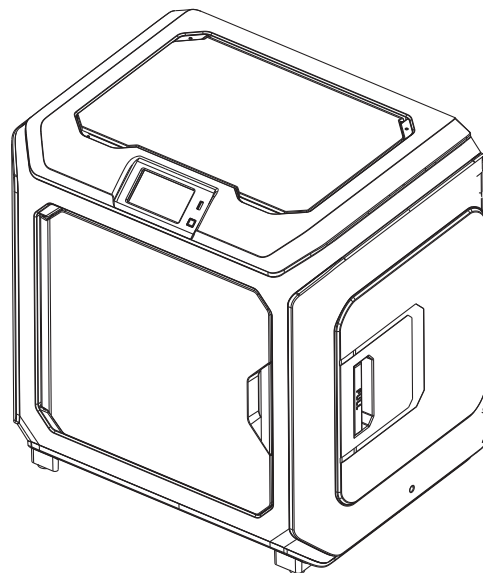

7. Put the spool of filament on the spool holder, close the filament cover.

### 3.3 Loading and Unloading

#### [Loading]

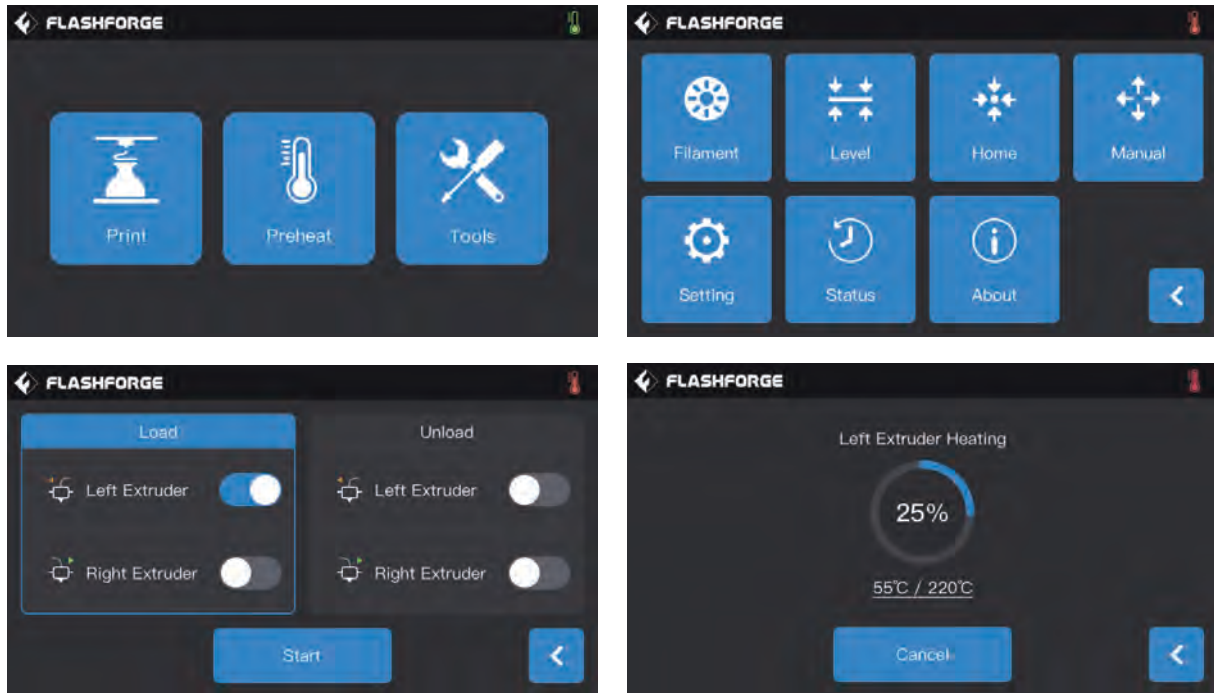

1. Tap [Tools]-[Filament]-target extruder[Load] in turns on the touch screen, wait for extruder heating up.

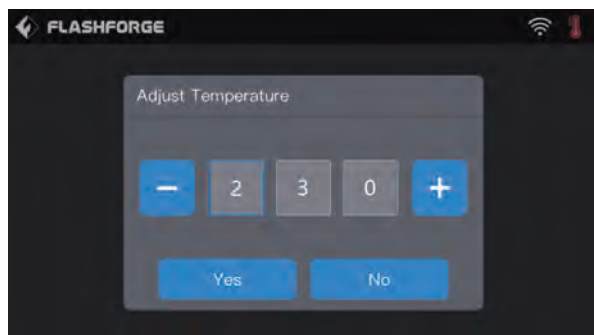

Click the temperature value, and a window for modifying the temperature value will pop up . The default filament loading temperature is 220 degrees. When high temperature filament such as ABS/ PC are needed, please click to modify the temperature value.

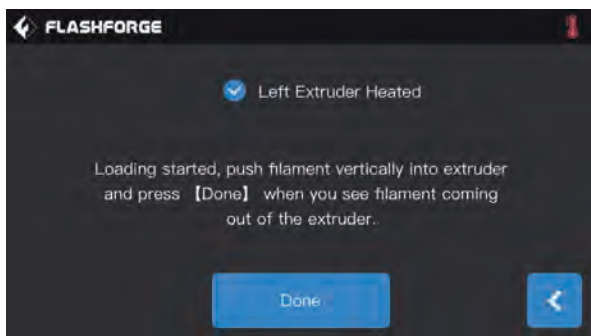

2. Install filament spool on the printer, thread filament through filament detecting components; Insert filament into filament intake until filament goes through white filament guidetube.

- When extruder heated up to the target temperature, press down the spring presser with left hand, and insert filament into filament intake until filament drive gear starts to load filament. Let white filament go, and insert white filament guidetube into extruder filament intake.
- Wait for even filament from nozzle. If is filament changing, please wait for same color of filament, then stop loading.

**Note:** Please loading before inserting filament into filament guidetube. Insert filament guidetube into filament intake after loading completed.

### [Unloading]

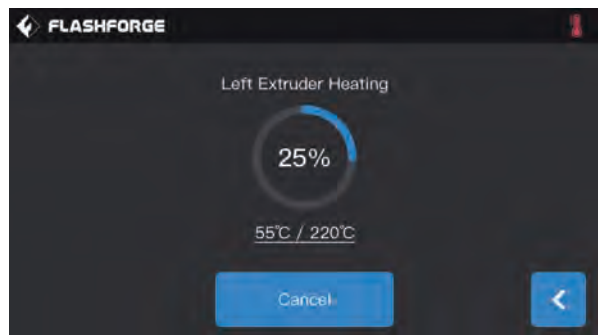
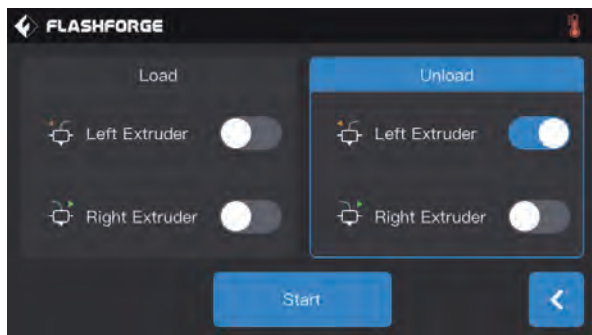
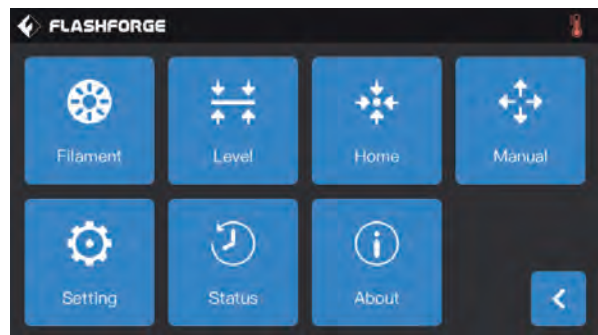
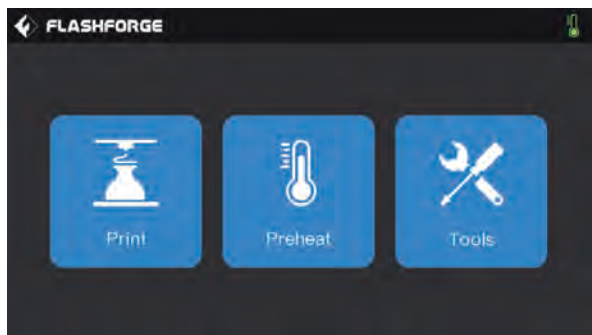

- Tap [Tools]-[Filament]-target extruder[Unload] in turns on the touch screen, wait for extruder heating up.

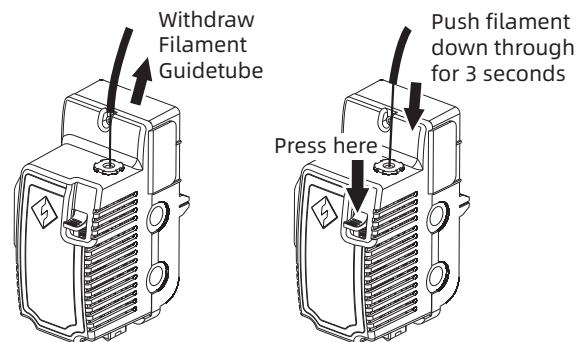
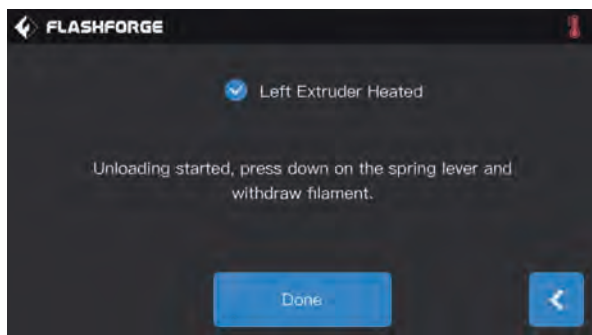

- When extruder heated up to the target temperature, wait for even filament from nozzle. Now, press down spring presser with left hand, pull out white filament guide tube with right hand, pull out filament quickly, unloading completed.

## 3.4 Calibration

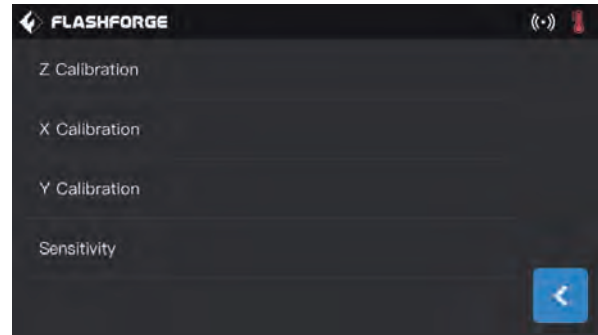
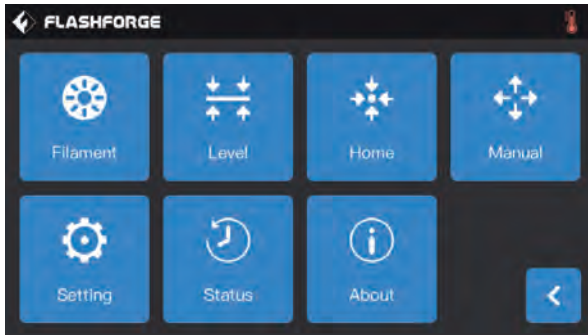

Tap [Tools]-[Setting]-[Calibration] in turns on the touch screen.

### [Z axis calibration]

1. Do leveling before Z axis calibration,leveling see Page 13.

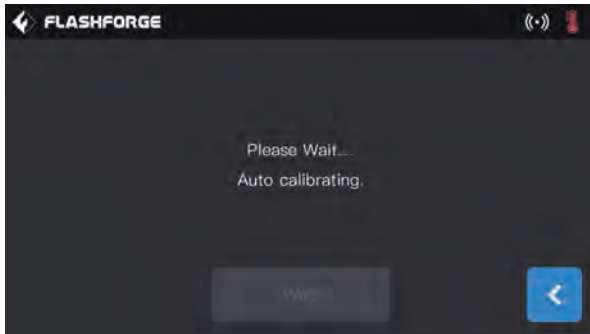

2.Tap[Z axis calibration],wait for calibration between nozzle and Z axis without pausing.

### [Setting]-[Calibration]-[Sensitivity]

**[Sensitivity]:** shows the sensitivity of sensor in the nozzle. The higher the value, the lower the sensitivity;  
When the sensitivity is too strong, it may cause an error report of z-axis calibration abnormal. When the equipment often prompts the z-axis calibration abnormal, please adjust the sensitivity of the sensor;increase the value.  
This function is factory default setting.

#### How to use this function?

When creator3 keeps reminding "please recalibration z-axis" or "z-axis error" before printing, and the platform continues to move upward after touching with the nozzle during manual adjustment.Your printer's sensor of z axis calibration may have malfunctioned.  
Please follow the following steps to adjust.

Click[Setting]-[Calibration]-[Sensitivity]

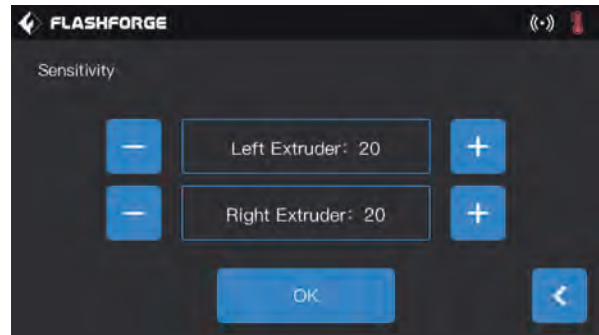
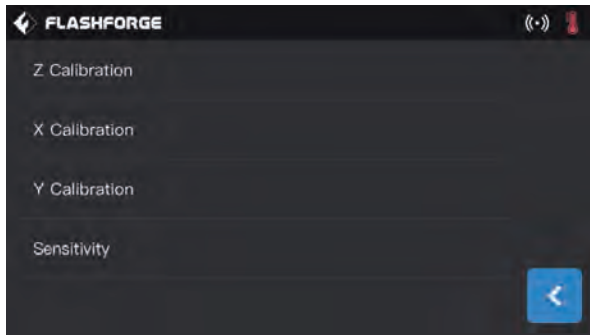

- The value should be adjusted to a larger value greatly if the piezoelectric plate is too sensitive.
- The value should be adjusted to a smaller value if the piezoelectric plate is not sensitive.
- Normal values are recommended at 20-25.
- When z-axis stops in the middle or stops without touching with the nozzle during printing, the corresponding nozzle sensitivity value should be increased.
- When the platform is still moving upward after contacting with the nozzle, the corresponding nozzle sensitivity value should be reduced.

### [X axis calibration]

By comparing if printing lines of two extruders coincide in the direction of X axis to judge if two extruders in the same X-axis.

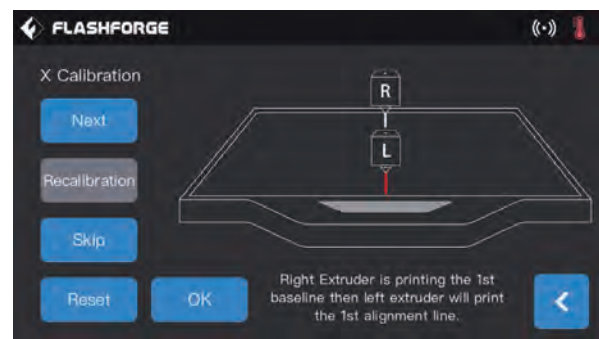

1. Tap[X axis calibration],wait for two extruders heating up to the target temperature, two extruders print one line in turns. After printing completed,check if two lines coincide; In the meanwhile, a confirmation notice pops up.

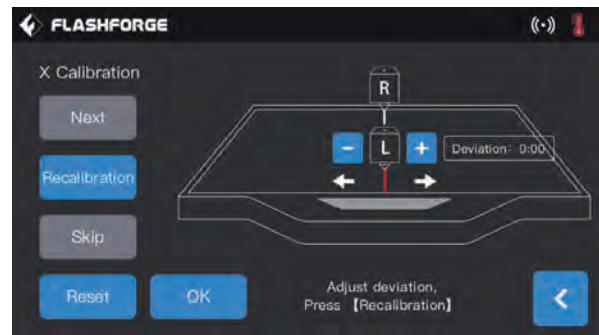
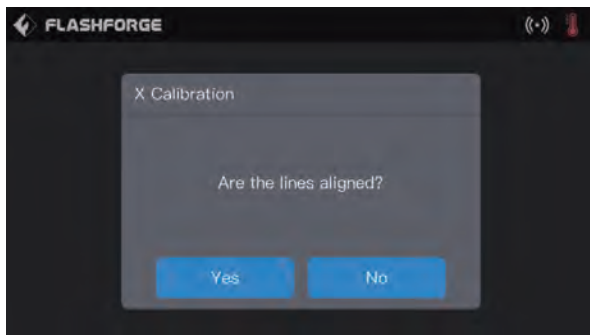

2. When the two lines do not coincide, click the next step, and there will be a prompt pop-up operation, and the nozzle will adjust the deviation to the left or right.

- **Next step:** shows judge next prompt operation and operate.
- **Recalibration:** The left and the right nozzle reprints one straight line respectively.
- **Skip:** The user knows that the two lines do not coincide, so there is no need to do the next prompt operation, so he can directly click "skip" to adjust the value deviation setting.
- **Confirm:** Save adjustive deviation value.
- **Back:** Exit the calibration page directly without saving the data in the face of the current operation.

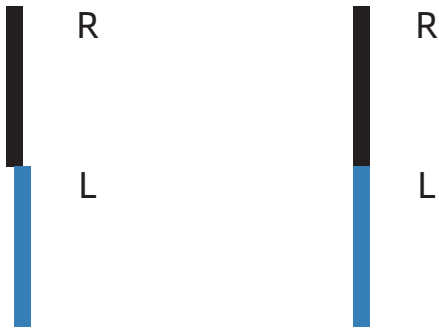

Deviation of two straight line      Two straight lines coincide

Please click the icon as shown in the picture and adjust the nozzle with the left nozzle as the indicator. Estimate the deviation. Enter the estimated value and click "recalibrate"; Repeat the above steps until the two lines coincide.

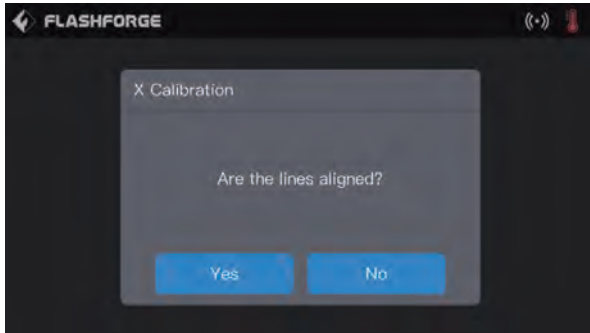

3. If two lines coincide completely, tap [Yes], X axis calibration completed.

### [Y axis calibration]

By comparing if printing lines of two extruders coincide in the direction of Y axis to judge if two extruders in the same Y axis.

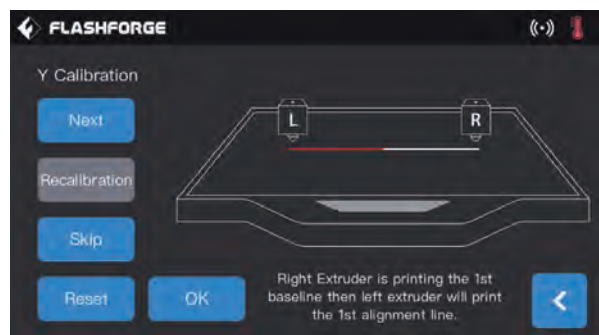

1. Tap [Y axis calibration], wait for two extruders heating up to the target temperature, two extruders print one line in turns. After printing completed, check if two lines coincide; In the meanwhile, a confirmation notice pops up.

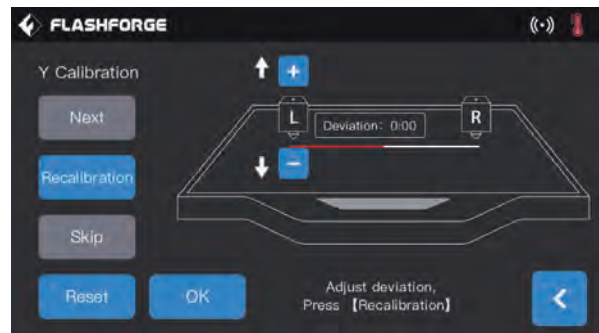
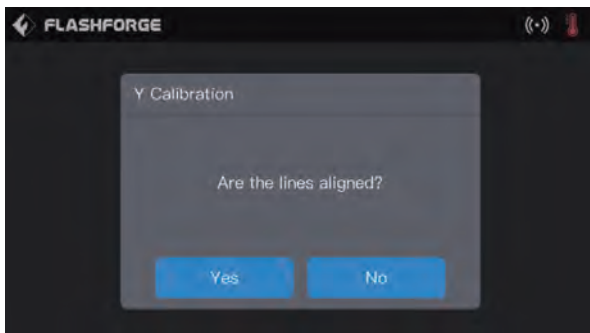

2. If two lines coincide completely, tap [Yes], Y axis calibration completed.

3. If two lines not coincide completely, tap [No], adjust extruder position according to actual situation. After adjustment completed, clean filament on the build plate, tap [Recalibration]; Repeat step 1 and step 2 until two printed lines coincide.

## 3.5 Internet Connection

### • Ethernet connection

Connect your Creator 3 with your PC via Ethernet cable, connection successfully when you see  on the right corner.

### • WiFi connection

Tap[Tools]-[Setting]-[WiFi],turn on WiFi to choose your WiFi. Connection successfully when you see  on the right corner.

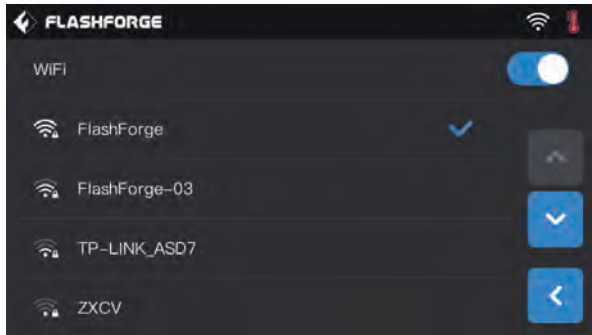

### • Hotspot connection

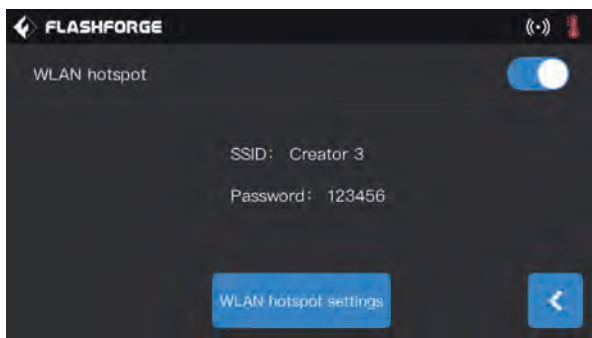

1. Tap[Tools]-[Setting]-[WLAN hotspot] to turn on hotspot.You can set hotspot name and password. Turn on the hotspot successfully when you see  on the right corner.

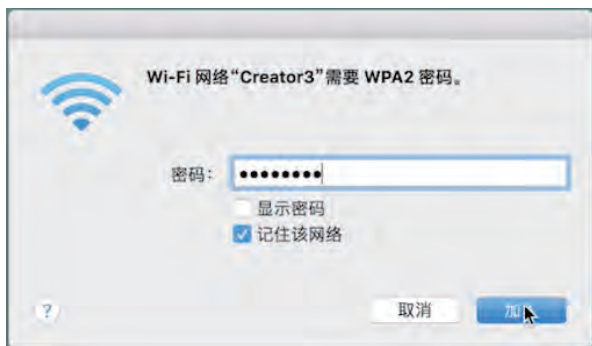

2. Use laptop to search your hotspot,connect and input password.

**Note:** If you have more than one printers,enter WLAN hotspot to modify hotspot name separately.

## 3.6 FlashPrint Software

### 3.6.1 Software Installation



FlashPrint

#### 1. Software Acquisition

You can choose from two methods to acquire FlashPrint software installation package:

Method 1 : To get the installation package from the USB stick in the toolkit.

Method 2 : Enter FlashForge official website: [www.sz3dp.com](http://www.sz3dp.com). Download software version you needed from Support - Support center-Flashprint.

#### 2. Software Installation and Start-up

Open setup and follow instructions to complete installation. Start FlashPrint after installation completed.

### 3.6.2 Software Interface

Choose machine type of Creator 3 from FlashPrint menu [Print]-[Machine Type], the main screen displays. Interface overview shown as follows:

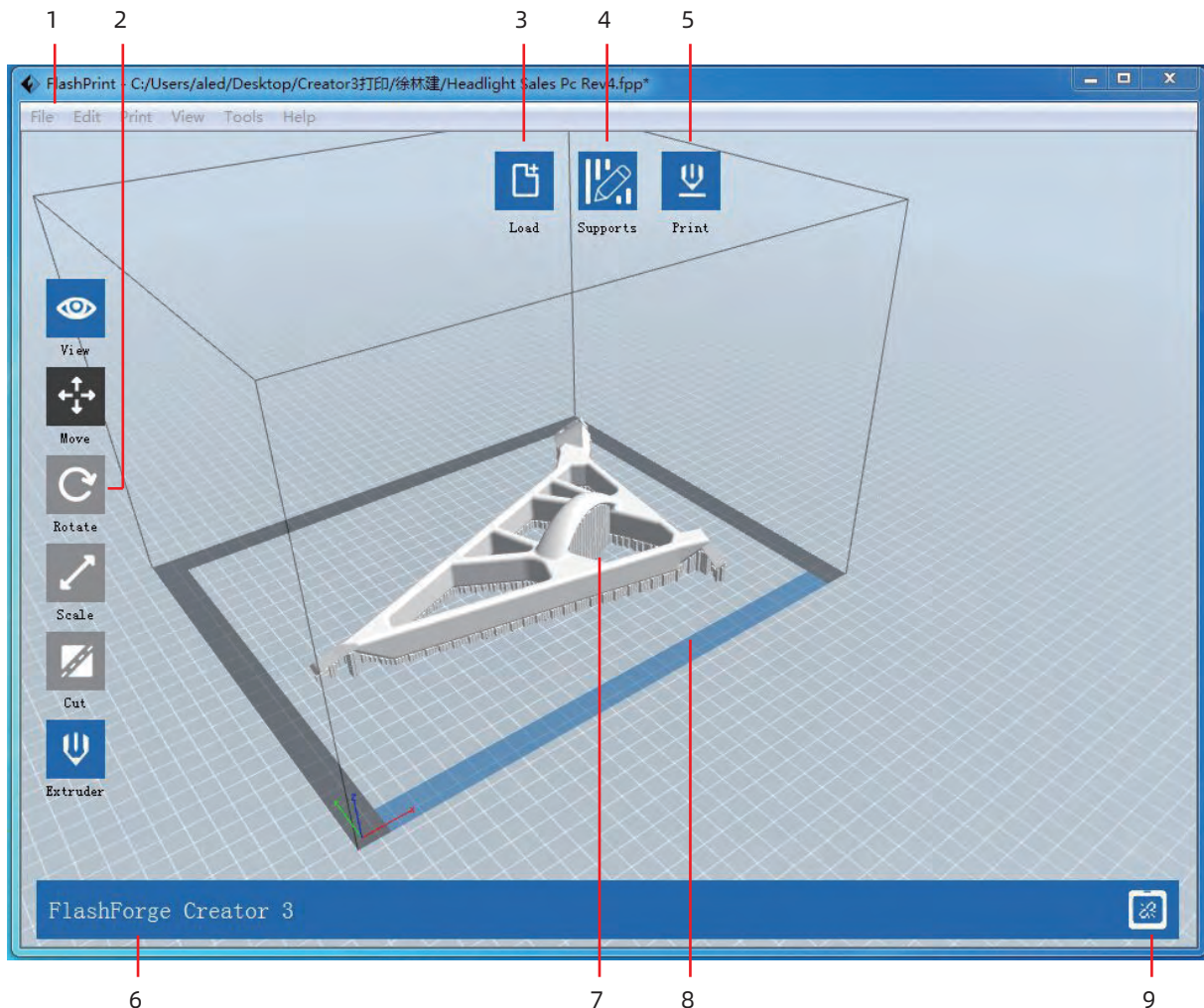

1. Menu bar  
6. Printer type

2. Adjust zone  
7. 3D models

3. Load model file  
8. Build plate front direction

4. Support setting  
9. Printer connection status

5. Print



### 3.6.3 Set Dual Extruder Print

Set left extruder support filament, right extruder structure filament ( right extruder as a default ) , follow the procedures below:

#### In expert mode:

1. Load the model;
2. Choose support type, Tap[Supports]>[Supports Options]>[Linear], and check[Touch Platform Only], tap[OK];
3. Auto add supports, tap[Supports]>[Auto Supports], go back and save;
4. Tap[Print], enter the parameter setting page;
5. Regular page, select profile , such as Creator 3 PLA;
6. Regular page, tap[Adapt soluble support filament]>[PVA]>[Adaptable];
7. Tap[Save Configuration]

Click [File]-[Preferences]-[Print]-choose [Expert Mode] you can set the parameters for printing.

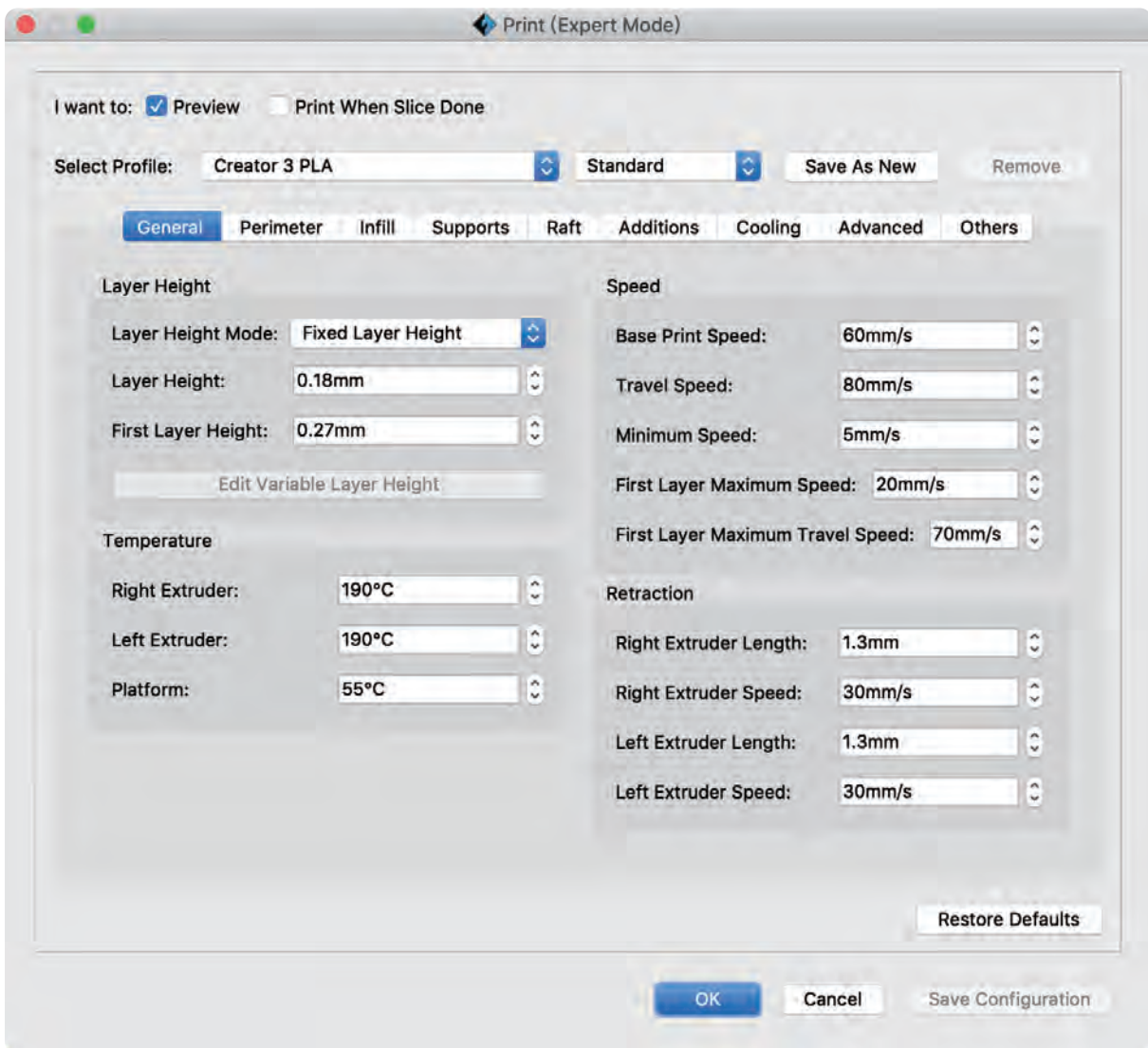

**In basic mode:**

1. Load the model;
2. Choose support type, Tap[Supports]>[Supports options]>[Linear], and check[Touch Platform Only], tap[OK];
3. Auto add supports, tap[Supports]>[Auto Supports], go back and save;
4. Tap[Print], enter the parameter setting page;
5. Suggest to use structure filament as material right and soluble support filament as material left;
6. Check[Wall] in the resolution, other system default;
7. Tap[Save Configuration]

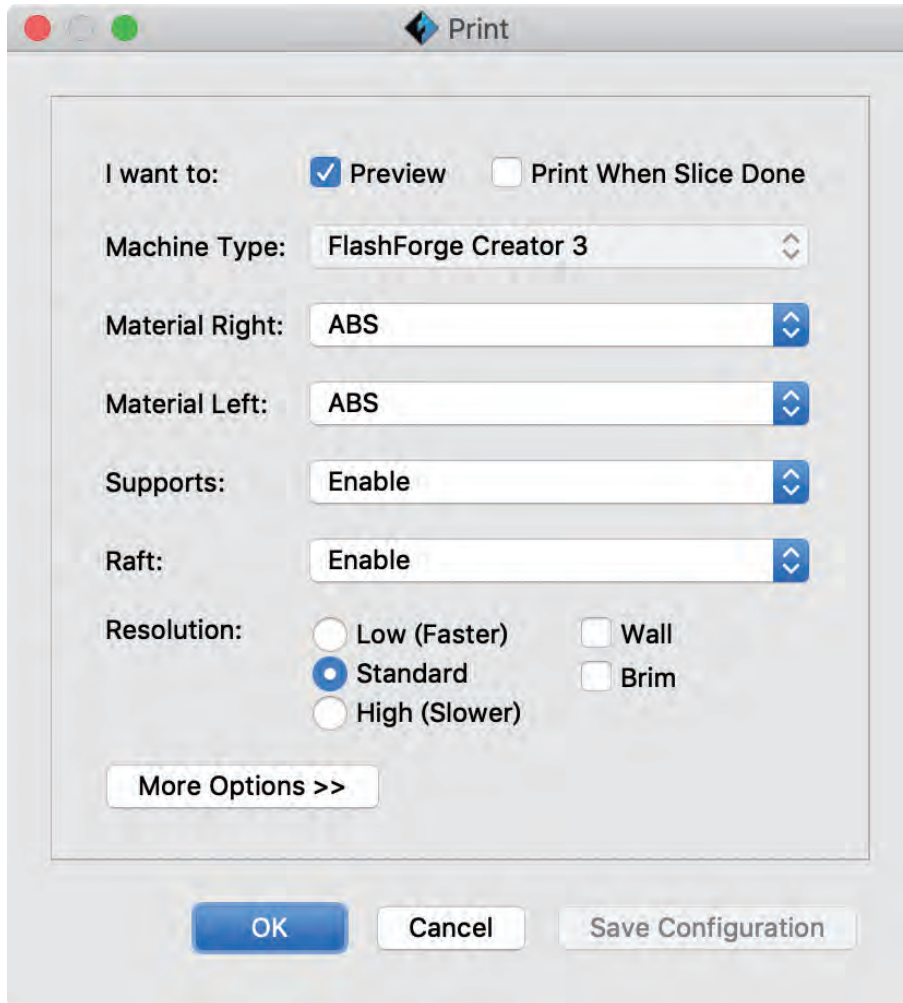

### Mirror/ duplicate mode:

If you want to print two same model, please choose the mirror or duplicate mode, the printer will print those two model at same time.

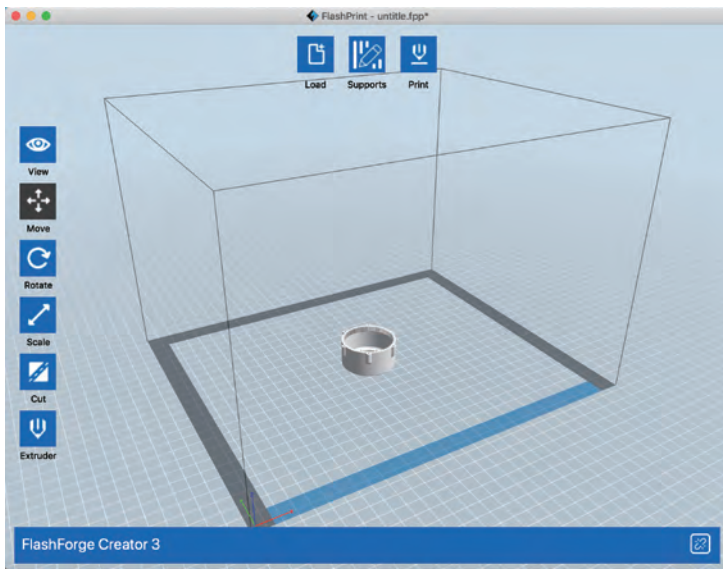

Load the model first, please note the mirror and duplicate support model size is smaller than 133mm (X axis direction)

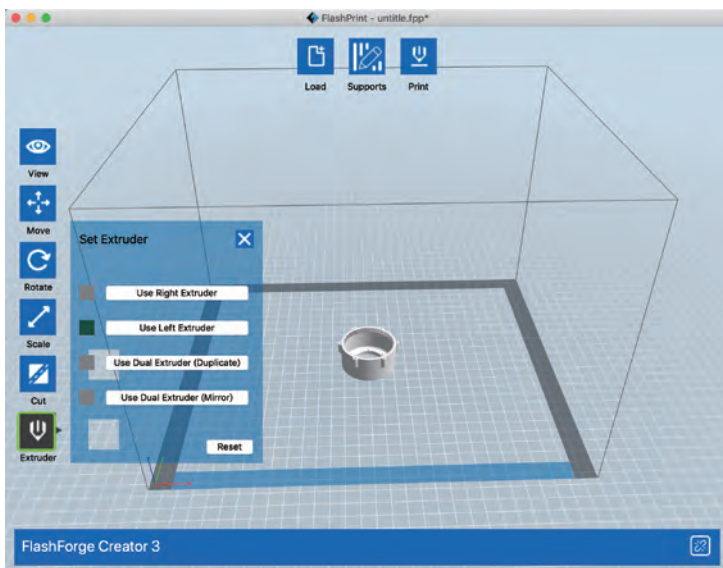

Click [Extruder], choose [Ese Dual Extruder (Dupliacte)] Or [Ese Dual Extruder (Mirror)]

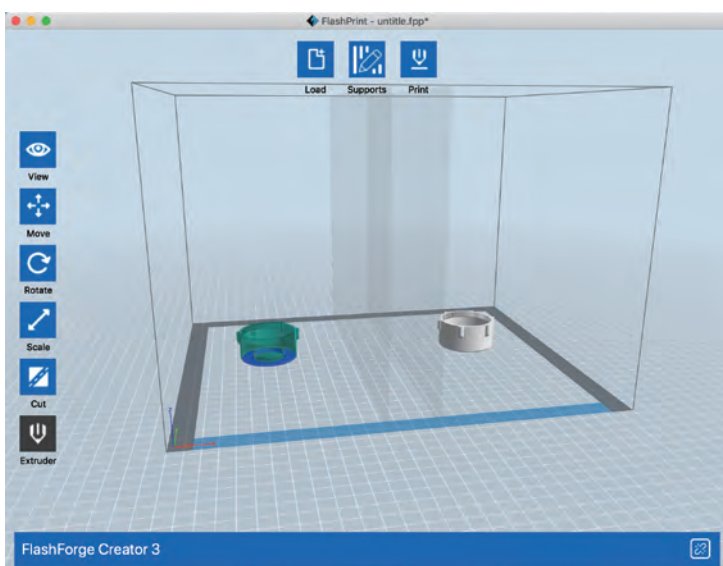

The interface will be show like this.

## Notes on mirror and duplicate mode:

### Duplicate and mirror mode:

Since the heights of the left and right sprinkler heads are different after installation, the software will automatically add a compensation layer to compensate for the difference in height when slicing, so that the printing heights of the left and right sides are the same. When the z-axis is calibrated, take the right nozzle as the reference and record the height difference of the left and right nozzle.

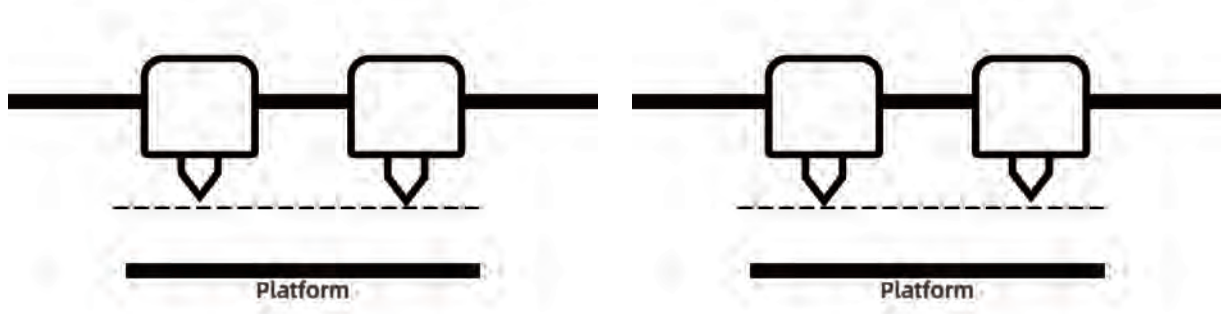

Left nozzle is lower than right nozzle: right nozzle prints cal pad;  
Right nozzle is lower than left nozzle: left nozzle prints cal pad;  
The height difference is less than 0.2mm, cal pad will not be printed.  
Compensation layer with height difference less than 0.2mm does not print.



The compensation layer (Cal pad) is printed first. Easy to remove by sticking to the raft. If the raft is not added, the compensation layer directly acts on the model, which is difficult to remove. so we highly recommend to add a raft when choosing mirror or copy mode to print.

# 4. Operation

## 4.1 Filament

### 4.1.1 Filament Compatibility

Creator 3 is equipped with independent dual extruders, which is suitable for PLA,ABS,PETG,Nylon (PA), PC, HIPS and PVA. Independent dual extruder filament combination extrusion situations, see below:

**Default left extruder as a support**

**Dissolvable filament:**

Left extruder	Right extruder
PVA	PLA
PVA	NYLON
HIPS	ABS
HIP	ASA
SHIPS	PC
HIPS	PETG
HIPS	HIPS

PVA: Water soluble support filament

HIPS: HIPS can be dissolved in d-Limonene

**Insoluble filament combination:**

Left extruder	Right extruder
PLA	PLA
ABS	ABS
ASA	ASA
PC	PC
PA	PA
PETG	PETG
PA-CF	PA-CF
PA-GF	PA-GF

Creator 3 is able to print PACF, because of the material of the nozzle is not the hardened, the nozzle will be worn. It's estimated that printing 1-2kg of PACF, will need to change a new nozzle and have to equip with a strong extruder. Standard device equipped with a standard feeding extruder.

While Creator 3 is adopted with open type filament system, we still suggest using Flashforge filament. All the Flashforge filament is tested professionally, and are possessed of optimized configuration files, which ensures perfect print effect.

**Storage of PVA /PA**

Direct exposure to the air, it is easy subject to moisture and softening, print bad easily after softening, so please store the PVA in dry box when printing. It should be stored in sealed bag or dry box.

### 4.1.2 Print Setting

Each type of filament needs different setting for best print effect.

If using prepared models of Flashprint, setting completed automatically under the circumstance of choosing correct extruder and filament.

For better adhesiveness of print product, we suggest applying a thin layer of glue (Use the glue stick in the accessory box) before printing.

**Adaptability of filament parameters**

Different filament brands have different filament characteristics. When using creator 3, it is recommended to use expert mode to find a suitable parameter to ensure better printing quality.

- Thickening and increase flow rate of the first layer are beneficial to the adhesion.
- When printing small models (or environment temp is higher than 25 degree) with PLA: suggest to set platform temperature to 45 degrees.
- When printing big models (or environment temp is lower than 10 degree) with PLA: suggest to set platform temperature to 70 degrees.
- Print PVA as support, suggest to set speed to 40%.

## 4.2 Print Start-up

Please complete the leveling, loading and calibration correctly with the guidance of User Guide at first print.

- **Print from internal memory card**

Tap[Tools]-memory card icon on the touch screen, choose printed files saved in internal memory card already. The print file copy by this method is not supported.

- **Print form USB stick**

Tap[Tools]-USB stick icon on the touch screen, choose printed files saved in USB stick already. Support to copy the print file to device internal memory card.

- **Print from Network Transmission**

The network transmission printing method is limited to the device and the computer within the same LAN, regardless of the use of wired network connection or wireless network connection.

1. Refer to page 22 Internet connection to connect successfully.

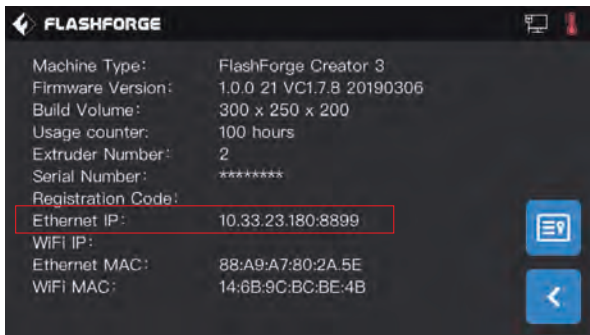

2. Tap[Tools]-[About] in turns on the touch screen, check and record Ethernet IP address:10.33.23.180(The example is for reference only, with the local IP address as the criterion.).

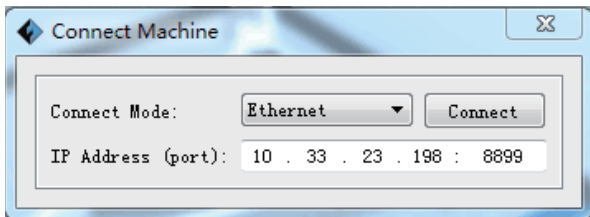

3. Tap FlashPrint menu bar in turns [Print]-[Connect machine], choose[Ethernet]connection, input:10.33.23.180:8080(The example is for reference only, with the local IP address as the criterion).

After connecting successfully, you will see  on the bottom right corner.

• **Print from hotspot connection**

1.Refer to Page 22 hotspot connection to connect successfully.

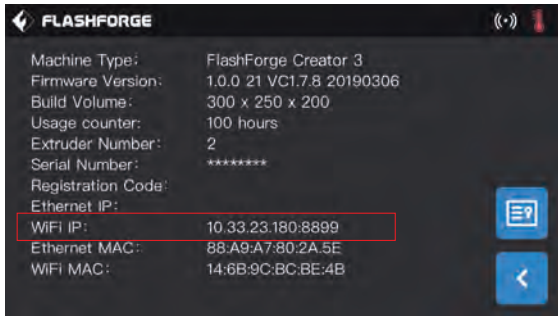

2.Tap[Tools]-[About] in turns on the touch screen, check and record WiFi IP address:10.33.23.180(The example is for reference only, with the local IP address as the criterion.)

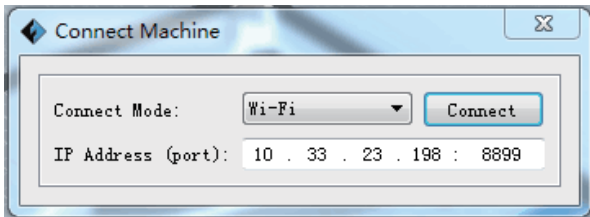

3.Tap FlashPrint menu bar in turns [print]-[connect machine],choose[Wi-Fi]connection,input:10.33.23.180:8080(The example is for reference only, with the local IP address as the criterion).

After connecting successfully, you will see  on the bottom right corner.

• **Print from FlashCloud**

1. Turn on WiFi or Ethernet to connect the internet.
2. Tap[Tools]-[Setting]to turn on FlashCloud.
3. Enter FlashCloud website: <http://cloud.sz3dp.com> to operate:

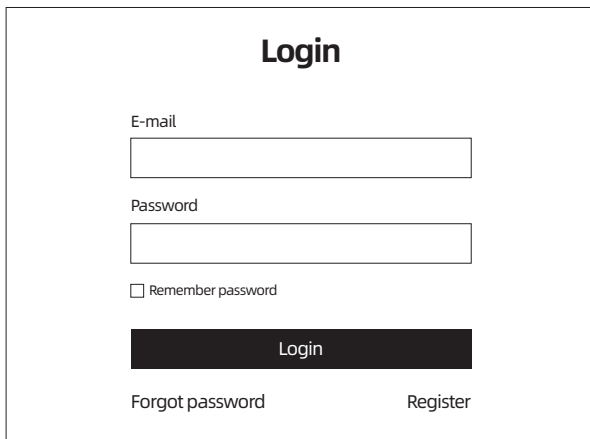

① Register FlashCloud account and login in on FlashCloud website: <http://cloud.sz3dp.com>.

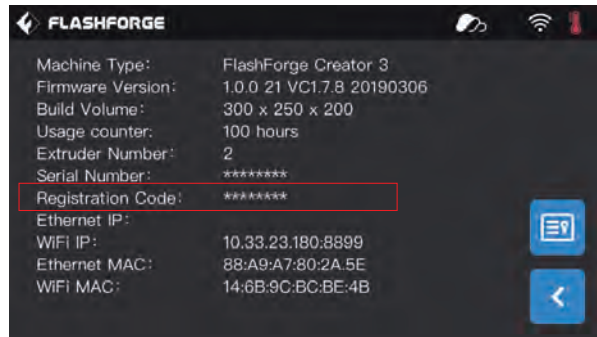
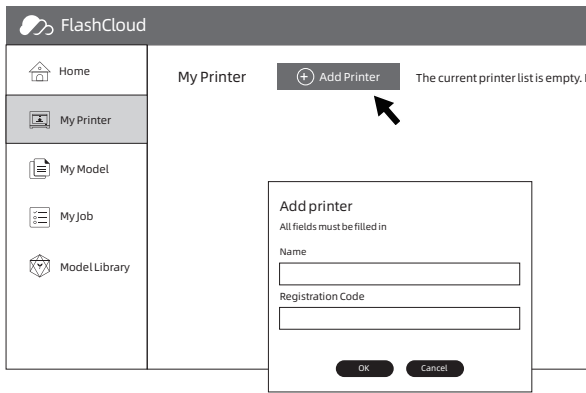

② Tap[Add Printer] on[My Printer],fill in printer name and registration code.(after turning on FlashCloud, check registration code on [Tools]-[About]).

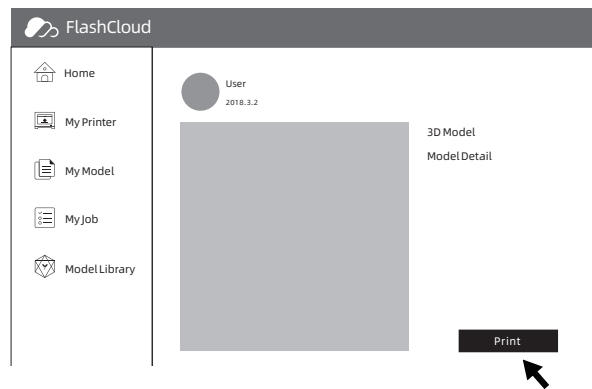
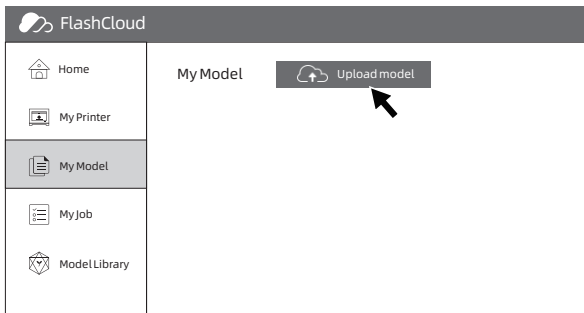

4. Choose one model from model library or upload your STL.file,tap[Print] to enter simple model edit interface.

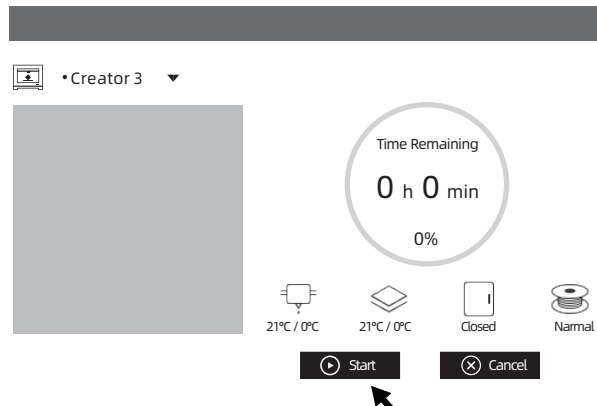
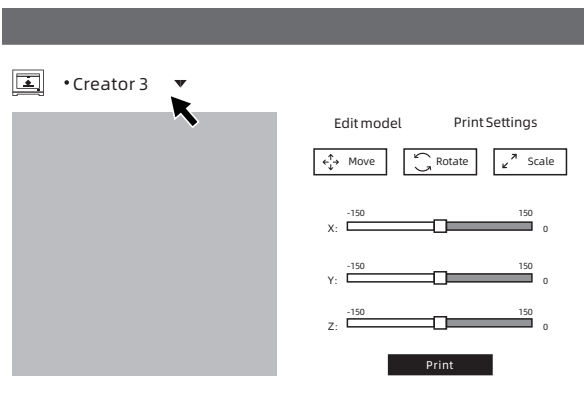

5. Choose the printer to do print job from pull-down menu.(The printer must be added to my printer)

6. Tap[Start],the printer starts to print.

**Note:** For security reason,on printer is used for one FlashCloud only, if you need to change FlashCloud account, please delete this machine with the original account.



## 4.3 Model Removal

**Warning!** Be careful of your body position when using manual tool to remove the model from build plate. Sudden tool slippage and improper body position may cause injury.

**Caution:** Do not scratch build plate when removing the model. Scratches in build plate will cause modeling errors.

- **Model cooling**

Let build plate and model cool down themselves when printing without using glue stick, you can remove model easily from build plate.

- **Use scraper**

Remove model with a scraper when model still attached to the build plate after cooling. Keep the scraper parallel to build plate, and insert it into model bottom, you can remove model successfully.

If necessary, remove build plate from the printer, then remove model from build plate with a scraper.

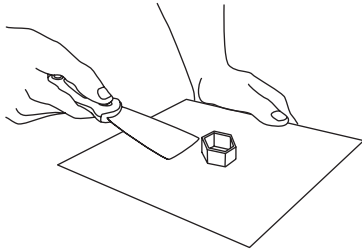

- **Use water**

If glue stick is used when printing, and neither of above methods is effective, wash build plate with warm water to dissolve the glue after taking build plate from the printer.

The model can be removed easily after glue dissolved. If PVA is used, immerse build plate and model into water to dissolve PVA to remove the model.

## 4.4 Support Removal

When PVA used as support material, we suggest doing follow-up processing by immersing PVA into water to remove support.

### 1. Immerse model into water

Put models with PVA into water to dissolve PVA. The following methods of accelerating dissolution:

- Use hotter water to reduce dissolution time. If PLA is used as structure filament, make sure that the highest water temperature will not exceed 35° to avoid PLA deforming; if is nylon, the highest water temperature will not exceed 50° to avoid burning.
- Stir water to reduce dissolution time, PVA dissolves faster in running water.
- Immerse model in the water for 10 minutes, then use pliers to remove most of support and put model in the water again, thus PVA dissolving faster.

### 2. Wash with water

Wash residual PVA with water after PVA completely dissolved.

### 3. Dry the model

Dry model completely. Do extra post-processing of model if necessary.

### 4. Wastewater treatment

Wastewater is easily cleaned because of PVA biodegradability. When the waste water pipeline is connected to the waste water treatment plant, the waste water can be discharged through the waste water pipeline. After disposal of wastewater, flush it with hot water for 30 seconds to remove excess PVA in the drainage pipe to avoid long-term blockage.

Water is available for repeated use, but immersing multiple models may increase dissolution time, we suggest using new water in order to reach best effect.

## 4.5 Camera Connection

Remove the front cover of camera before using camera.

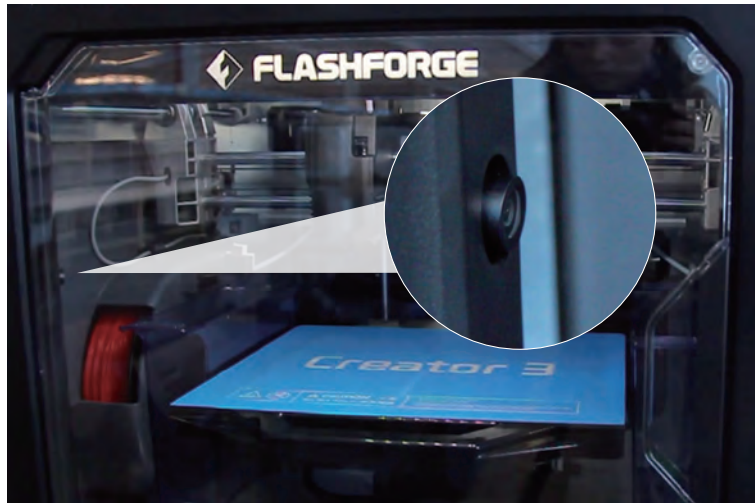

### · WLAN hotspot connecting camera

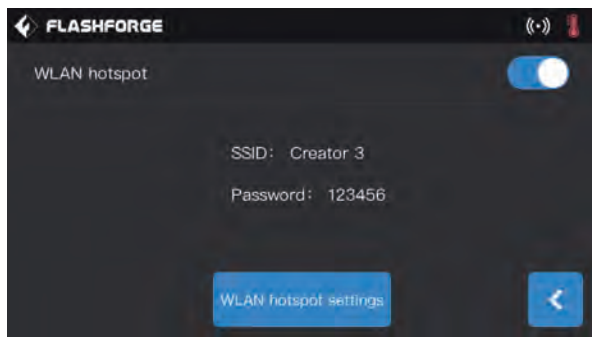

1. Refer to page 22 hotspot connection to connect successfully.



2. Tap[Tools]-[Setting]-[About] in turns on the touch screen, check and record WiFi IP address:10.33.23.180(The example is for reference only, with the local IP address as the criterion.)



3. The computer successfully connected to WLAN hotspot within the same LAN.



4. Input and enter address: 10.33.23.180:8080(The example is for reference only, with the local IP address as the criterion)., Tap[Stream]to check Creator 3 camera.

**Note:** The result is all same to use computer,mobile phone,iPad to turn on [Stream].

• WLAN WiFi connecting camera

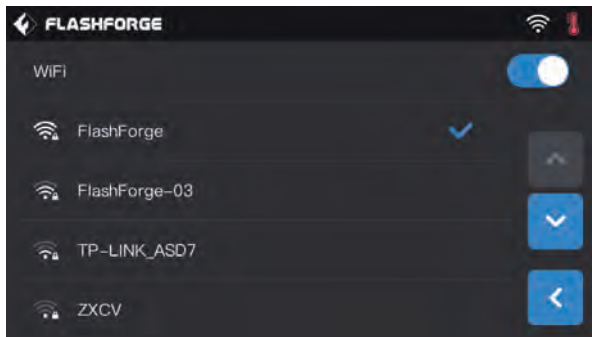

1. Tap[Tool]-[Setting]-[WiFi] in turns on the touch screen,turn on WLAN button to connect the network.

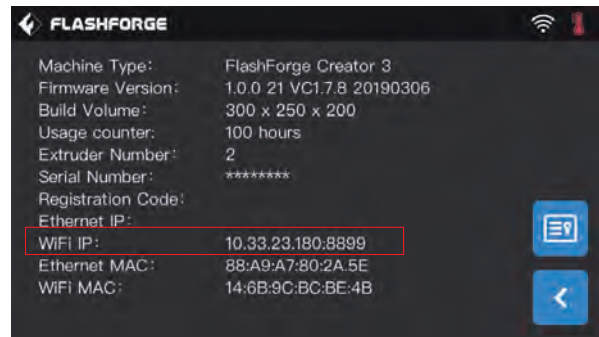

2. Tap[Tools]-[Setting]-[About],check and record WIFI IP address: 10.33.23.180(The example is for reference only, with the local IP address as the criterion).



3. Input and enter address: 10.33.23.180:8080(The example is for reference only, with the local IP address as the criterion)., Tap[Stream]to check Creator 3 camera.

**Note:** The result is all same to use computer,mobile phone,iPad to turn on [Stream].

• FlashCloud connection camera

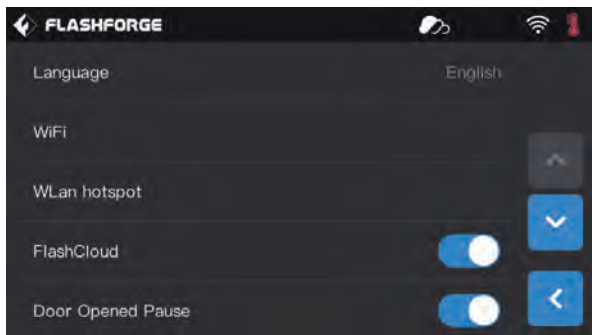

1. Turn on WiFi or plug in Ethernet cable to connect the network.  
2. Tap[Tools]-[Setting] in turns to turn on FlashCloud switch.

## Login

E-mail

Password

Remember password

**Login**

[Forgot password](#)      [Register](#)

3. Register FlashCloud account and login in on FlashCloud website: <http://cloud.sz3dp.com>

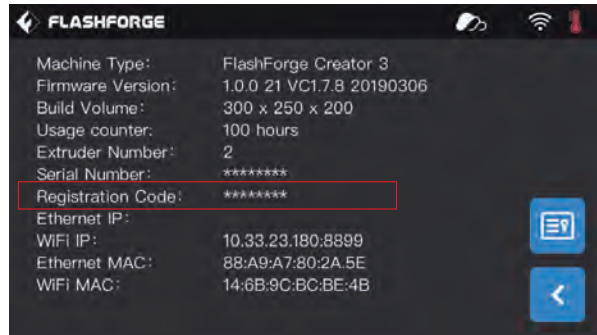
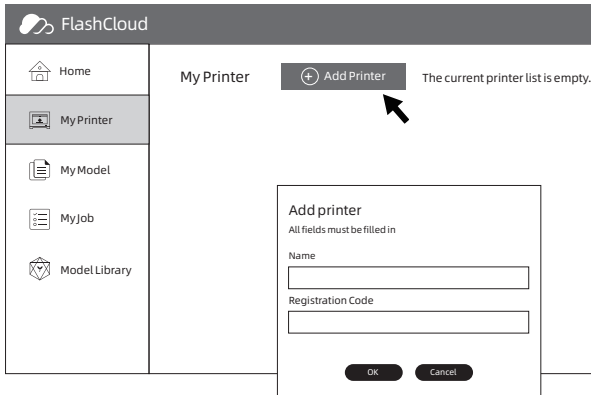

4. Tap [Add Printer] on [My Printer], fill in printer name and registration code. (after turning on FlashCloud, check registration code on [Tools]-[About]).



5. Choose your printer to enter printer detail page.

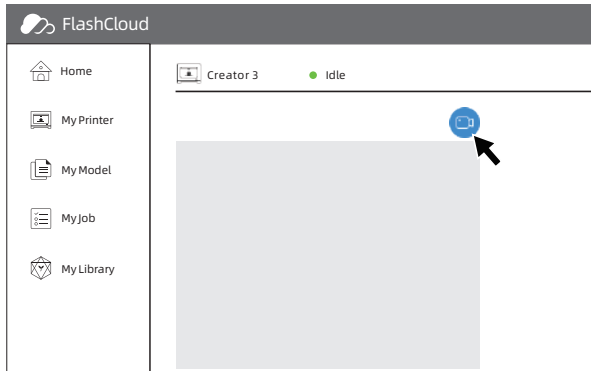

6. Tap camera icon indicated by the arrow, camera starts to work.

**Note:** Make sure printer has connected to network successfully, FlashCloud function is turned on and printer is on camera-on status.

# 5. Introduction of Touch Screen

## 5.1 Print

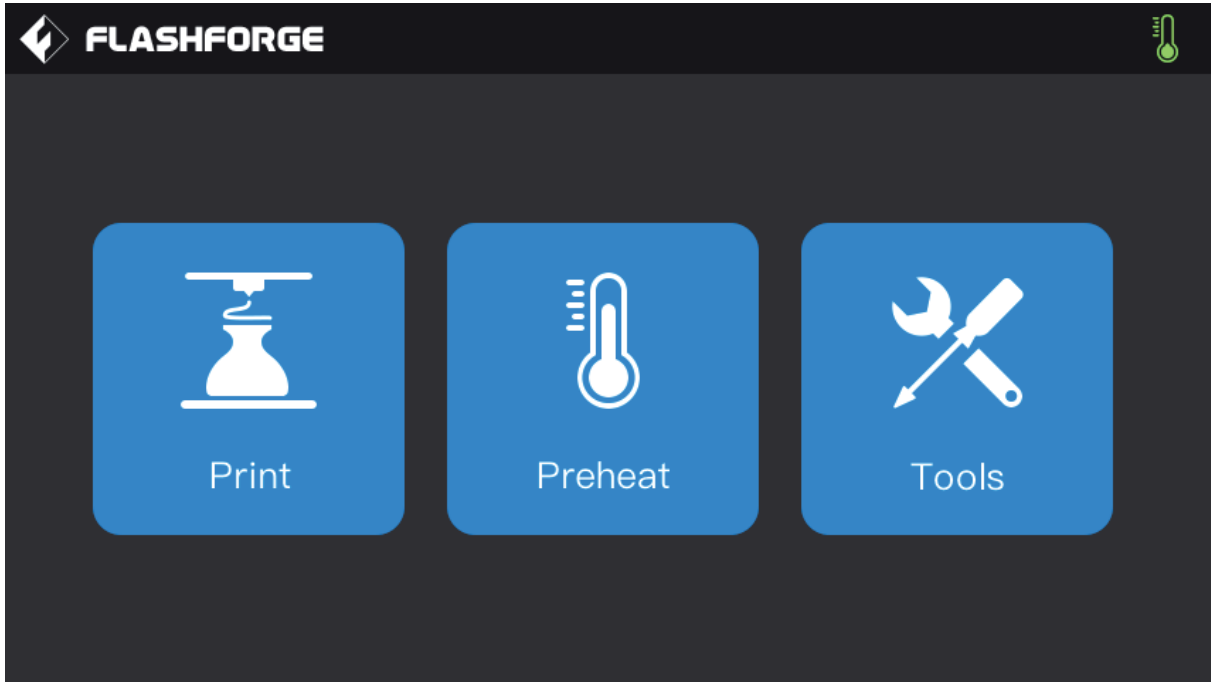

Tap[Print],choose your model.



Choose methods to read print files:

1. Read from printer local memory card
2. Read from USB stick.



Select the target print file among the list

1. **Build:** To begin printing.
2. **Copy:** To copy the files to the local memory card from the USB stick. (The button is not available while printing from local memory card )
3. **Delete:** To delete the print file.



### Print interface

1. **Abort:** To abort the print job.
2. **Pause/Resume:** To suspend or resume the print job.
3. **More:** Real-time check or change: filament setting, lights-off setting, print speed, print schedule, filament usage, print time and Z-axis coordinate
4. **Left/Right Extruder temperature, build plate temperature:**

Can be modified during printing.

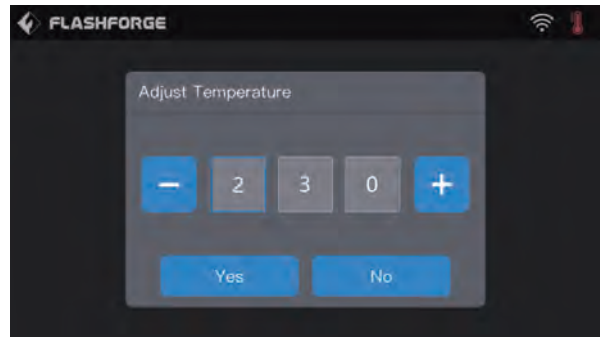

### To modify left/right Extruder and baseboard temperature:

After temperature has reached target temperature, temperature figure will be underlined in print interface, choose number box, modify extruder temperature by tapping '-' '+'. Tap [Yes] to save the setting while tap [No] to cancel the setting.

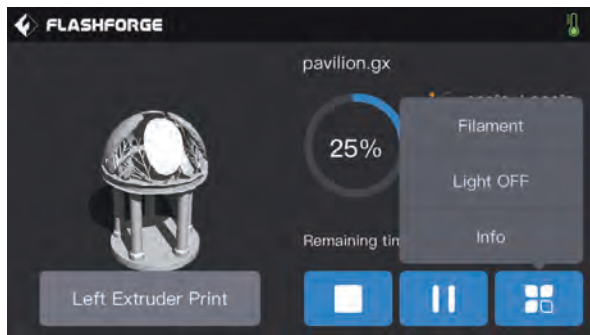

### Tap more buttons during printing

Real-time check or change: filament setting, light-off setting, print details (print speed, filament use, print time, Z-axis coordinate)

1. **Filament changing:** Tap [Filament] to change filament during printing. (This function works after pausing printing).
2. **Turn off the light:** Tap [Light off] to turn off the lights during printing.
3. **Details:**
  - a) **Print speed:** To set print speed value during printing.
  - b) **Filament use:** Check filament usage amount. (m)
  - c) **Print time:** Check print time
  - d) **Z-axis:** Check Z-axis coordinate
  - e) **Back:** Cancel tool instructions, go back to print interface.

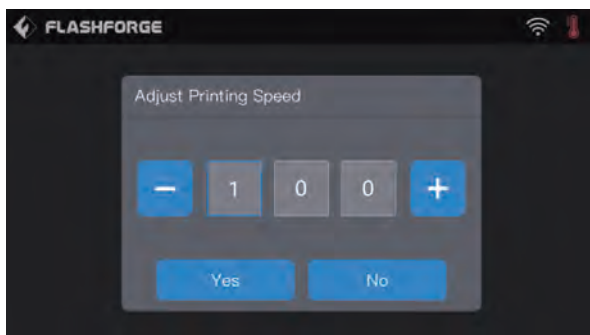
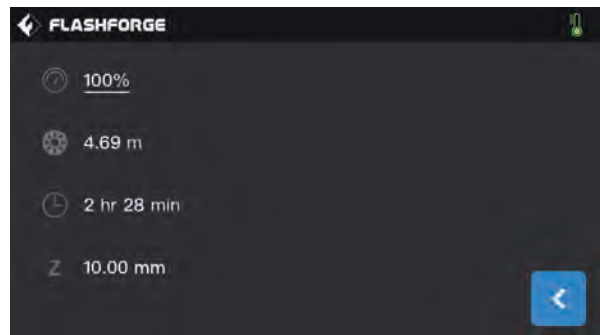

### To set extruder printing speed during printing

To set the printing speed during printing: Tap [Yes] to save the setting while tap [No] to cancel the setting.

## 5.2 Preheat

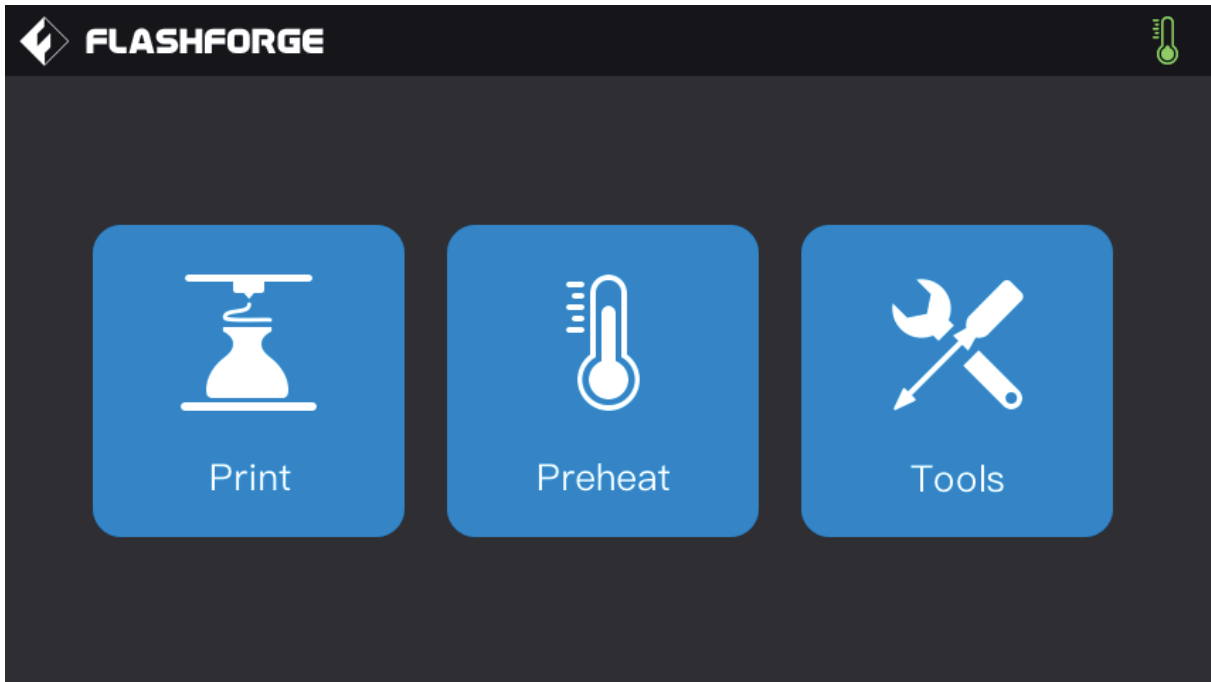

Tap[Preheat],enter preheat interface.

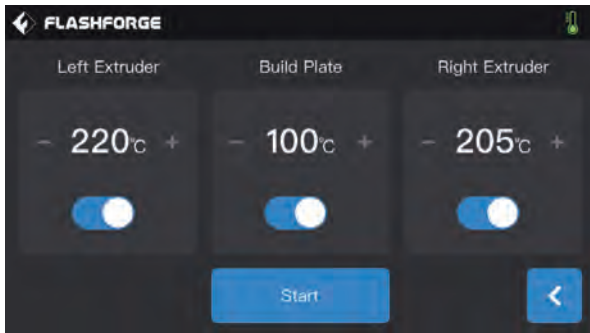

### Preheat interface:

1. **Turn on/off:** turn on left/right build plate preheating function, turn off left/right build plate preheating function.
2. **Temperature value:** tap '-' '+'temperature value to set preheating temperature.
3. **Start:** tap[Start],extruder or build plate starts to preheat.

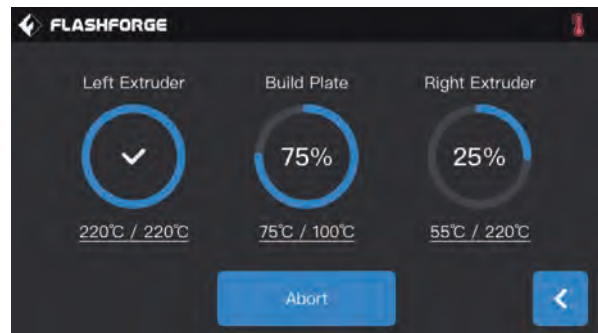

### Extruder/build plate heating interface:

1. **Actual temperature value;**
2. **Target temperature value;**
3. **Stop:** stop to preheat;

## 5.3 Tools

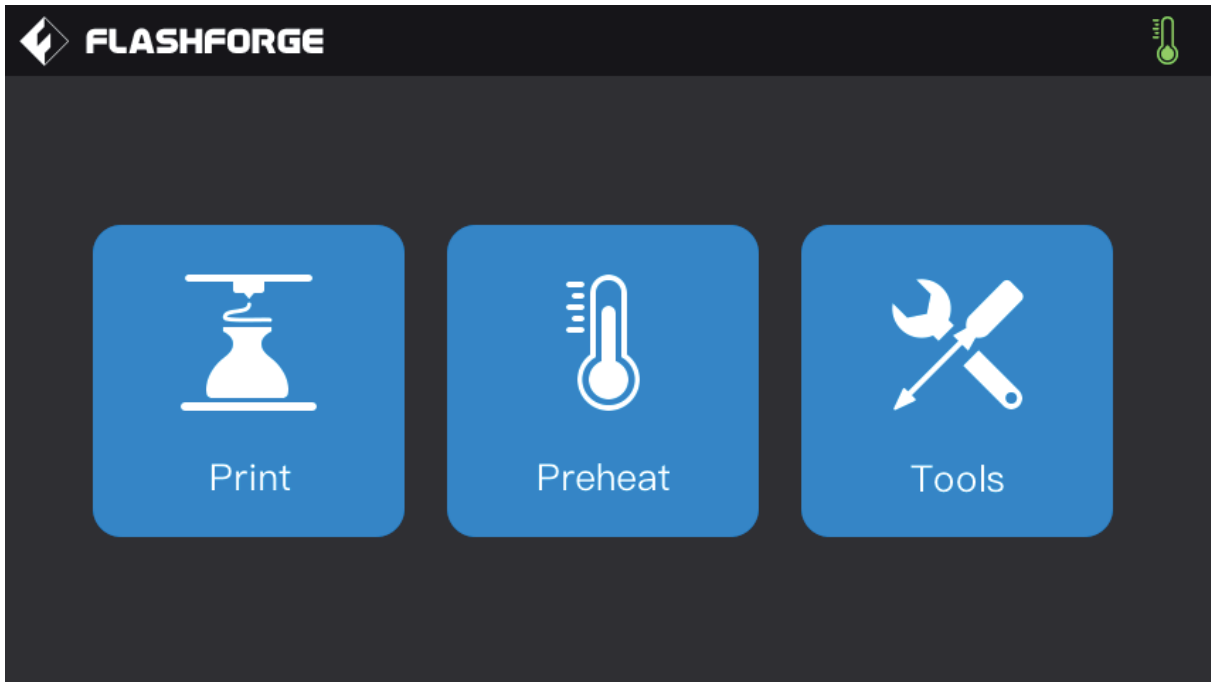

Tap[Tools] to enter tools setting interface.

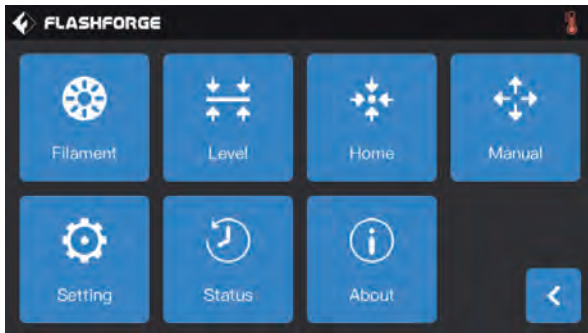

### Tools interface

1. **Filament change:** loading/unloading operation;
2. **Leveling:** level build plate;
3. **Zero returning:** to make printer X/Y/Z-axis go back to zero;
4. **Manual adjusting:** Manual adjust the position of X/Y/Z-axis;
5. **Setting:** Related functions setting;
6. **State:** Check printer real-time state;
7. **About:** Check printer version information;

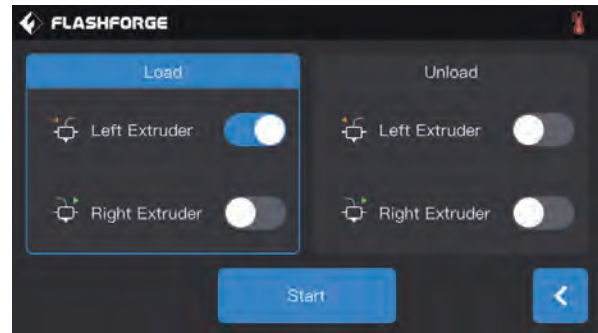

### [Tools]-[Filament]

Loading/unloading interface:

1. Loading interface;
2. Unloading interface;
3. Left extruder loading button;
4. Right extruder loading button;
5. Left extruder unloading button;
6. Right extruder unloading button;
7. Start: Tap[start],loading/unloading starts.



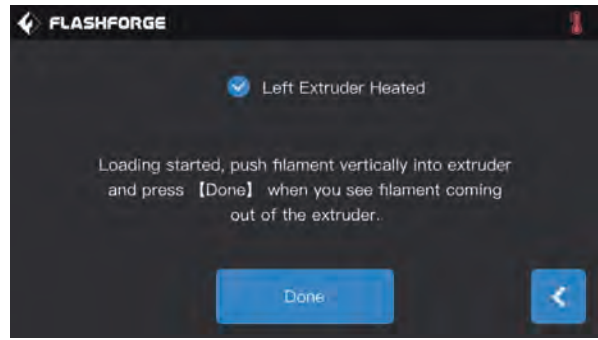

**Loading/Unloading operating interface:**

- a. Actual temperature value;
- b. Target temperature value;
- c. Abort, to cancel preheating;
- d. Completion: Operating by interface instructions;

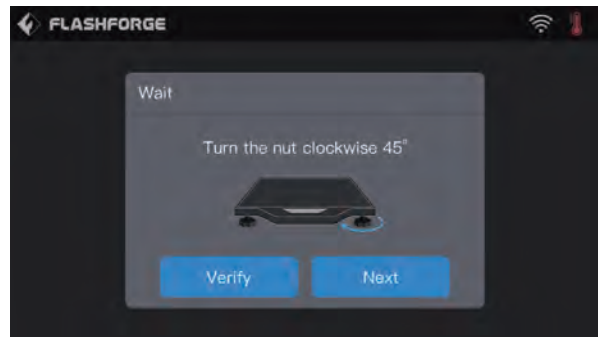
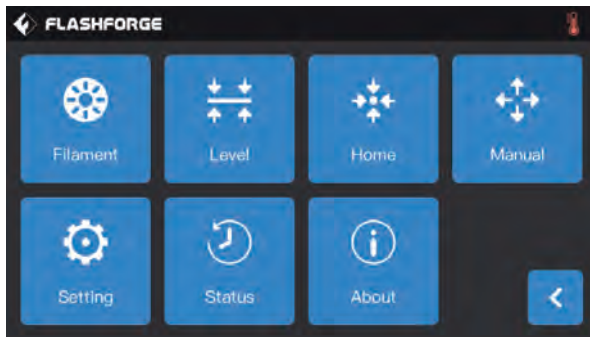

**[Tools]-[Level]**

Tap[Level], build plate starts. (more details refer to page 13) Touch screen shows instructions, tell you how to adjust build plate.

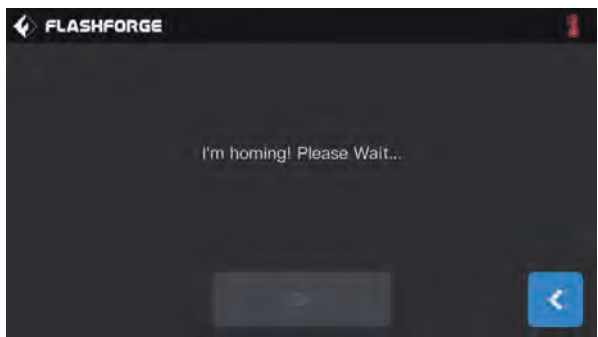
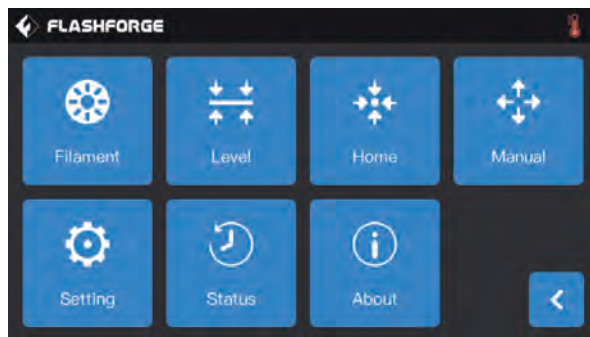

**[Tools]-[Home]**

Tap[Home], extruder and build plate go back to zero.

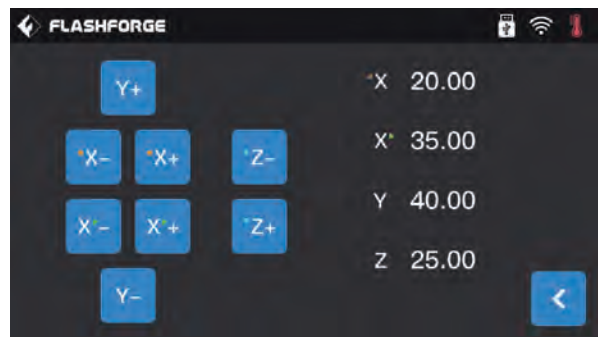
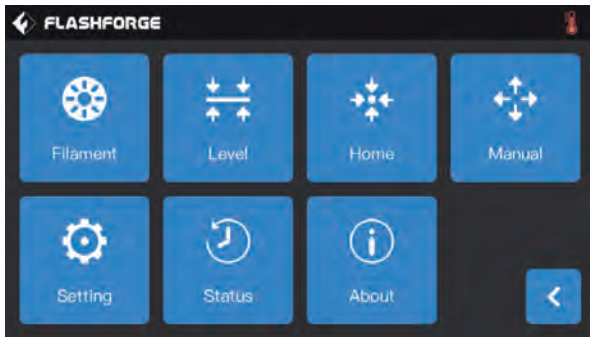

### [Tools]-[Manual]

Tap[Manual],enter manual adjustment mode:

1. **Y+**: The extruder moves to the zero point, that is, the back of the machine;
2. **Y-**: The extruder moves to the direction opposite to the Y+;
3. **X-**: The left extruder moves to the zero points, that is, to the right direction;
4. **X+**: The left extruder moves to the direction opposite to the X+;
5. **X-**: The right extruder moves to the zero points, that is, to the left direction;
6. **X+**: The right extruder moves to the direction opposite to the X+;
7. **Z-**: The build plate descends;
8. **Z+**: The build plate elevates.

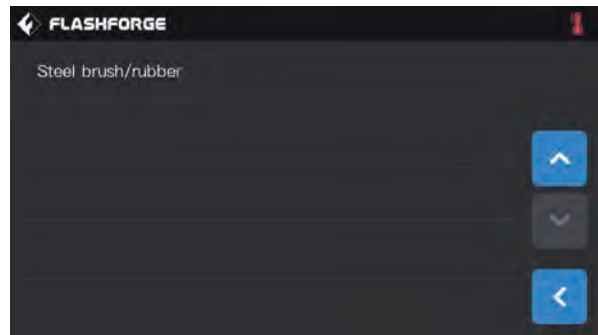
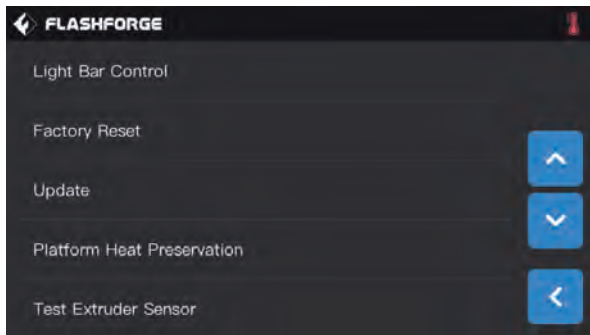
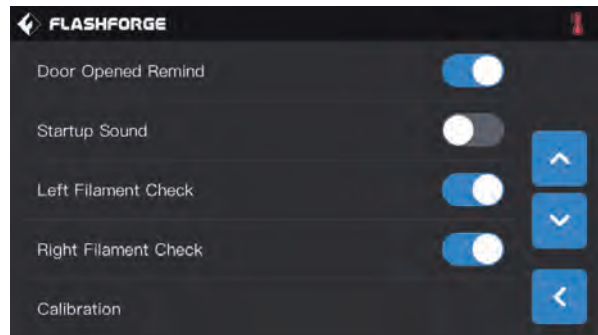
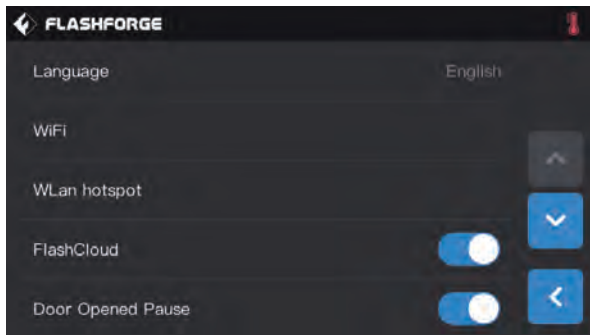

### [Tools]-[Setting]

Tap [setting]to enter setting interface

1. **Language**: To set the display language;
2. **Wi-Fi**: To turn on/off the Wi-Fi;
3. **WLAN hotspot**: To turn on/off the WLAN hotspot;
4. **FlashCloud**: turn off/on Cloud connection;
5. **Door Opened Pause**: To turn on/off the Door Opened Pause;
6. **Door Opened Remind**: To turn on/off the Door Opened Remind;
7. **Startup Sound**: To turn on/off the startup Sound;
8. **Left Filament Check**: To turn on/off the filament check on left extruder;
9. **Right Filament Check**: To turn on/off the filament check on right extruder;
10. **Calibration**: To adjust the initial distance between the extruder and the build plate;

11. **Light Bar Control:** To turn on/off the light bar control;
12. **Factory Reset:** Return to factory setting;
13. **Update:** To update the firmware version;
14. **Platform Heat Preservation:** When the printing finished, the platform will keep heating the current setting time;
15. **Test Extruder Sensor:**
16. **Steel Brush /Rubber:**

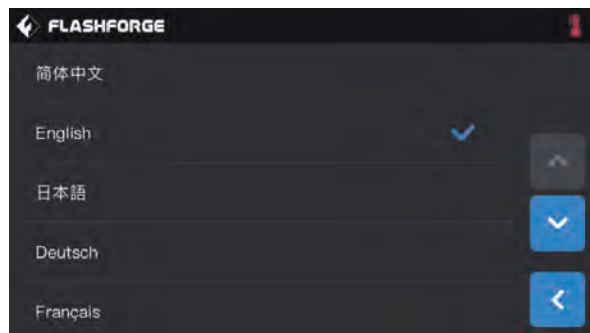
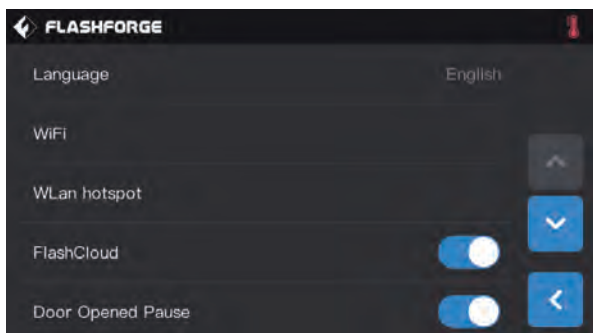

#### [Setting]-[language]

Tap [language] to enter language setting interface

1. Tap to choose the display language.
2. Page turning: Turn to the up/down menu

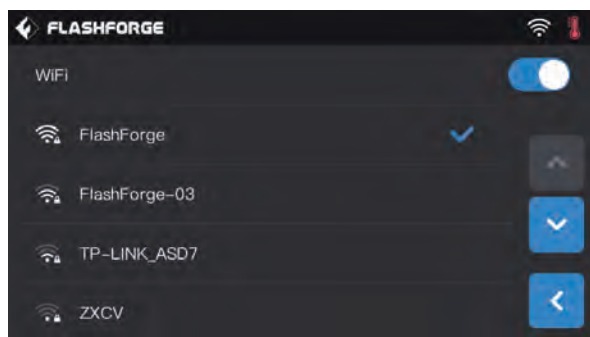
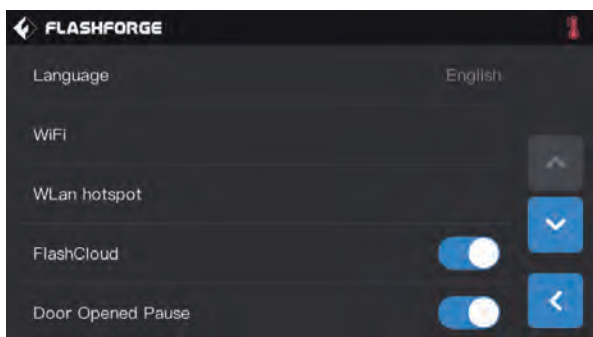

#### [Setting]-[WiFi]

Turn on WiFi function, the device can connect to network:

1. Remote file transfer and print. For details, see page 29 network transfer print.
2. Remote control device print state, for details, see page 34 WiFi connection camera.

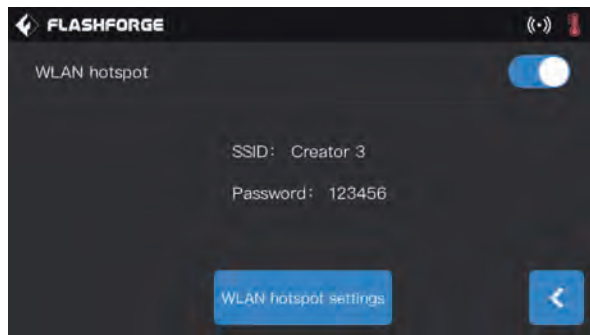
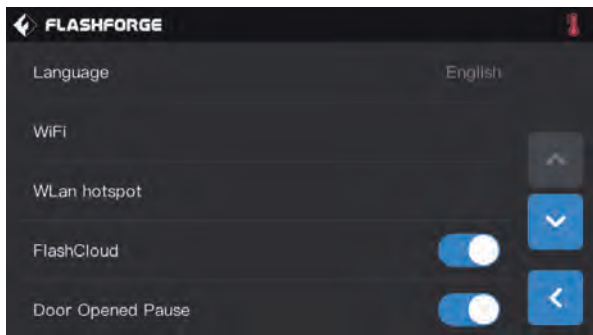

#### [Setting]-[WLAN hotspot]

Turn on WLAN hot-spot function, the device can connect to PC hot-spot:

1. Remote file transfer and print, for details, see page 30 hotspot connection print.
2. Remote control device print state, for details, see page 33 WLAN hotspot connection camera.

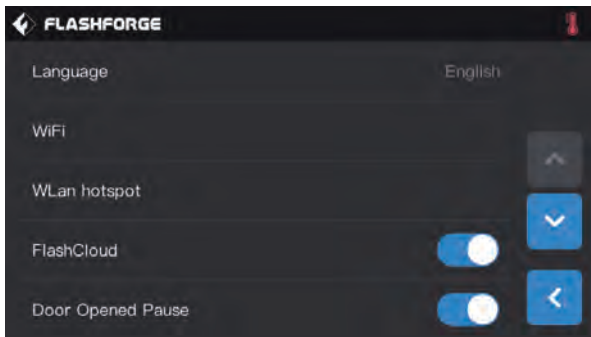

**[Setting]-[FlashCloud]**

Via FlashCloud, users break network restrictions:  
 1. Remote file transfer and print, for details, see page 30 Flash Cloud print.  
 2. Remote control device print state, for details, see page 34 Flash Cloud connection camera.

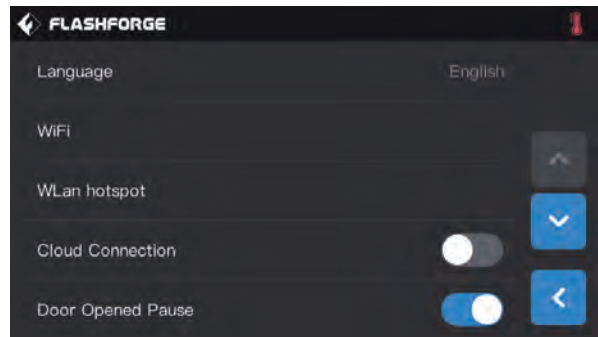

**[Setting]-[Door Opened Pause]**

After this function is turned on, print will stop when door is opened during printing.

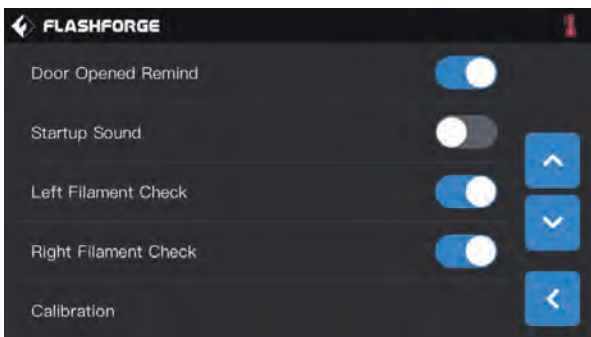

**[Setting]-[Door Opened Remind]**

After this function is turned on, Door opened note will pop out when door is opened during printing.

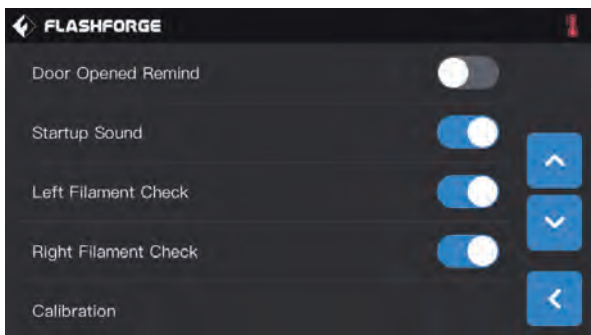
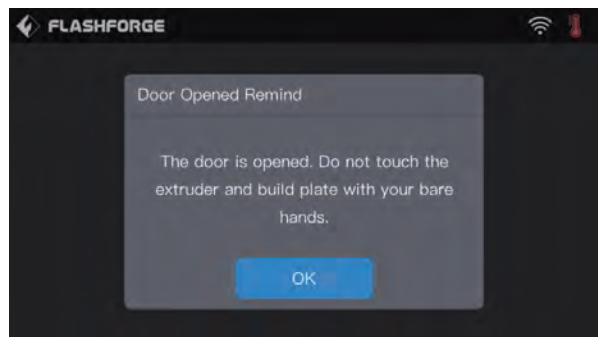

**[Setting]-[Startup Sound]**

Tap to turn on/off the sound when restart the printer.

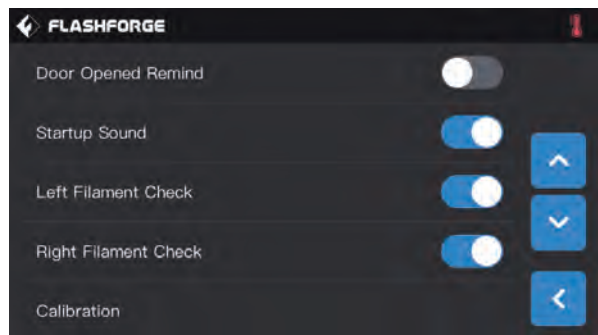

**[Setting]-[Left/Right Filament Check]**

Tap to turn on/off right/left filament check. After this function is turned on, the print will be detected when filament used up or print breaking off; Turn off this function when using external filament, ensure print successfully.

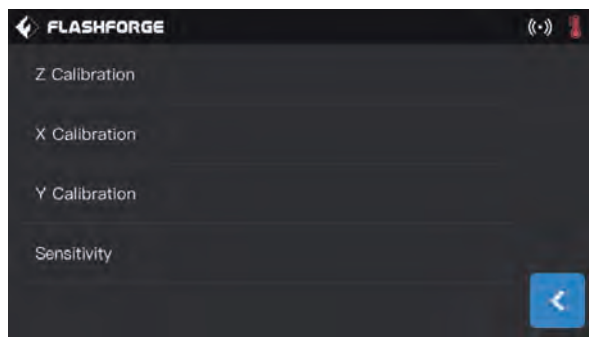
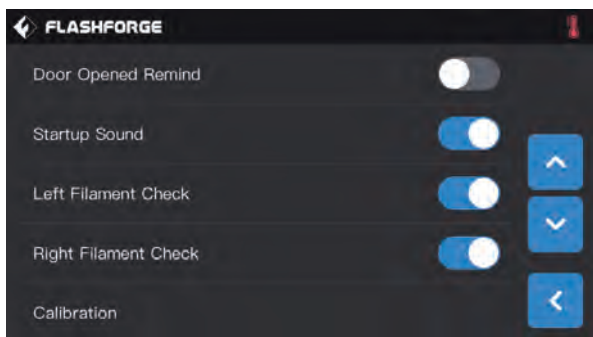

**[Setting]-[Calibration]**

Calibration includes Z axis calibration, Y axis calibration and X axis calibration. For details see Page 19.

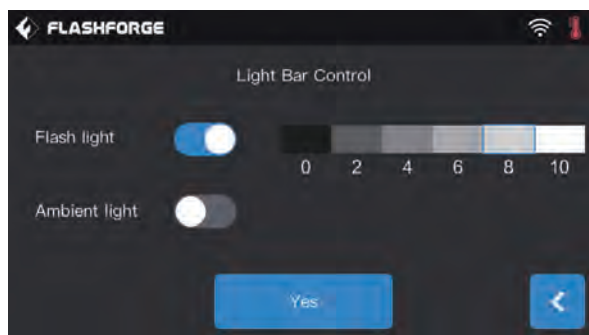
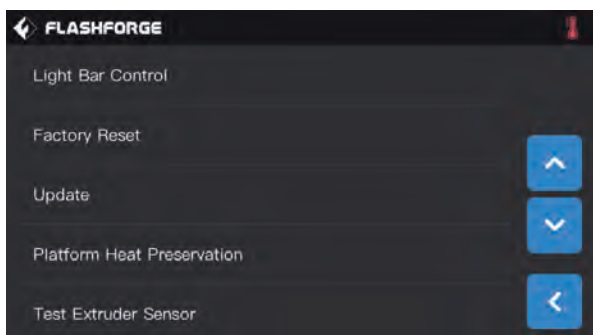

**[Setting]-[Light Bar Control]**

Turn on or off flash/ ambient light; light brightness can be adjusted according to your demands.

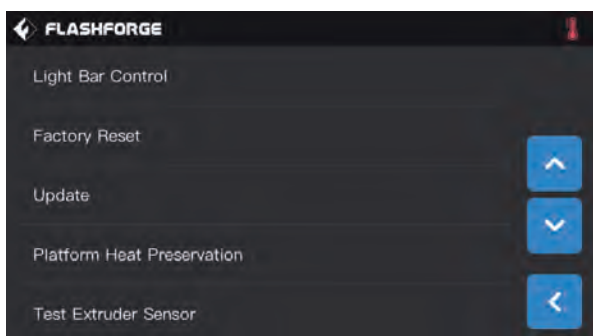

**[Setting]-[Factory Reset]**

Turn on this function, the device state restored to the factory fault setting.

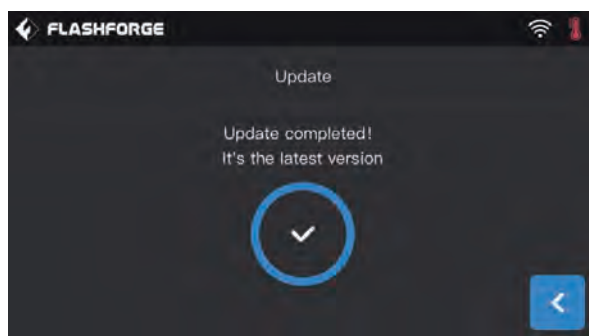
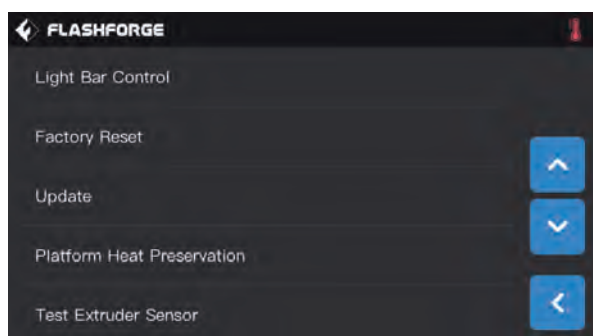

**[Setting]-[Update]**

Tap [update] when device connected to WLAN network. The device will update to the latest version automatically when needed. Reboot the device after update completed.

**Note: Do not cut off power and network, or printing fails.**

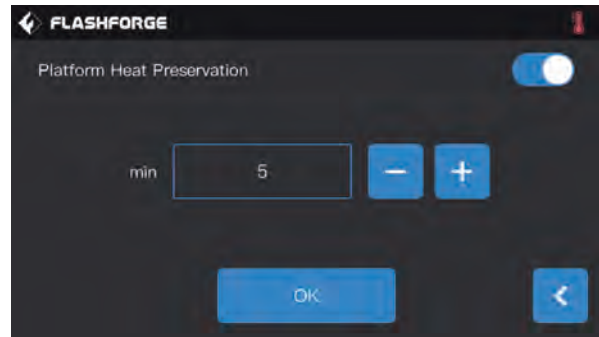
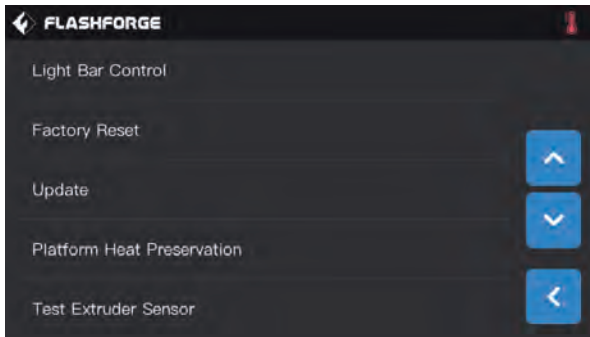

**[Setting]-[Platform heat Preservation]**

The insulation duration of the platform can be set from 1 to 10 minutes. When the printing finished, the platform will keep heating the current setting time. Reduce the heating time for printing the second model.

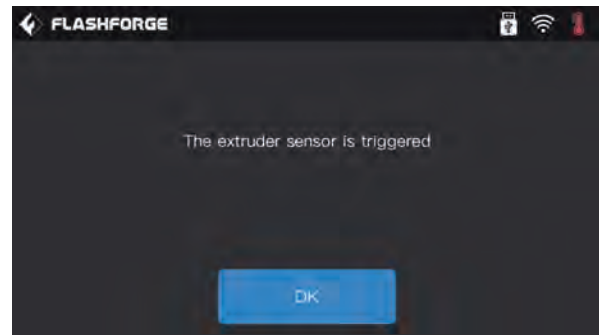
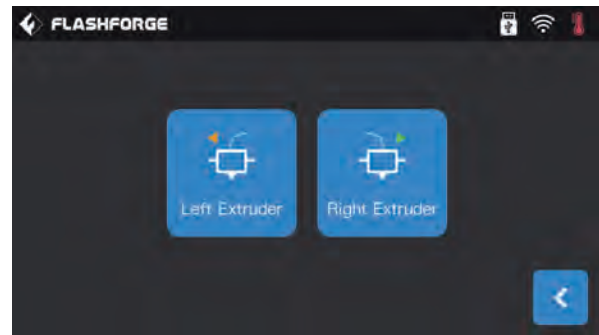
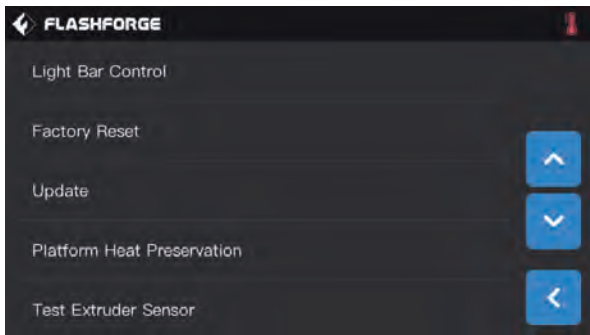

**[Setting]-[Test Extruder Sensor]**

The detection function of extruder sensor is able to detect whether the sensor is abnormal; If it cannot be triggered, please adjust the sensitivity of the sensor and try again. If it still cannot be triggered, the sensor is damaged, should be changed.

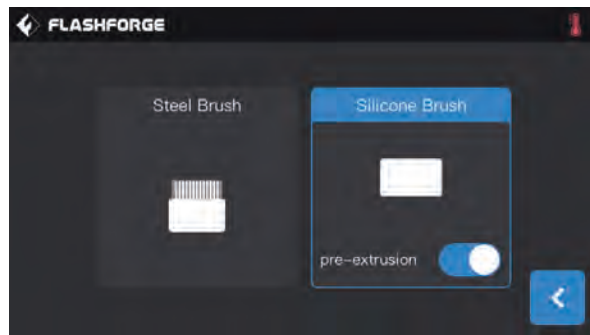
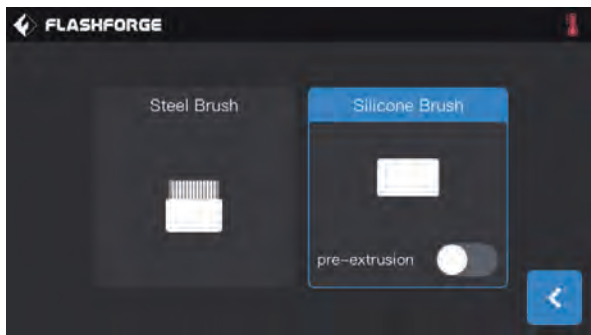
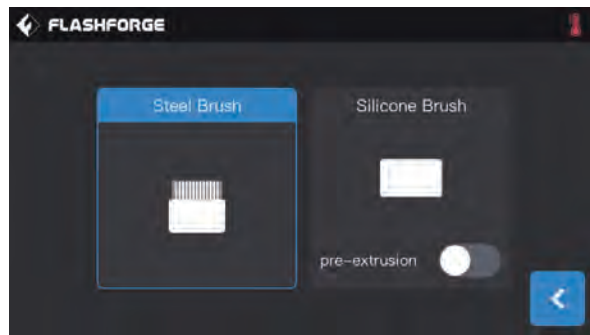
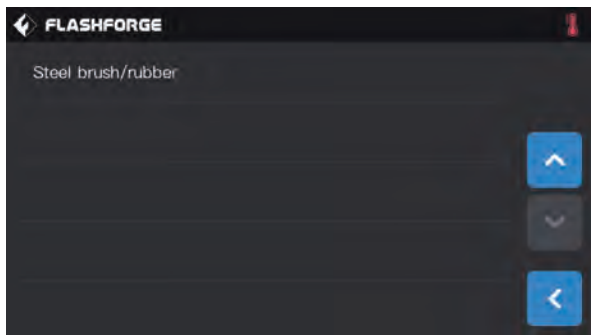

**[Setting]-[Steel Brush/Rubber]**

Nozzle-wiping options: the device supports two types of brush:

Steel brush : extruder moving at Y direction;

Metal panel: extruder moving at X direction; When the nozzle is switched, a section of filament will be spit out in advance to avoid the oozing. The rubber brush is a new option, suggest to use it.

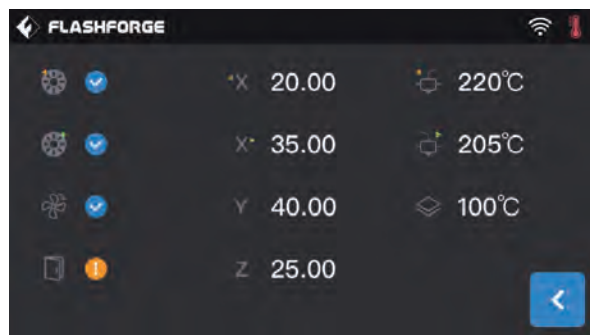
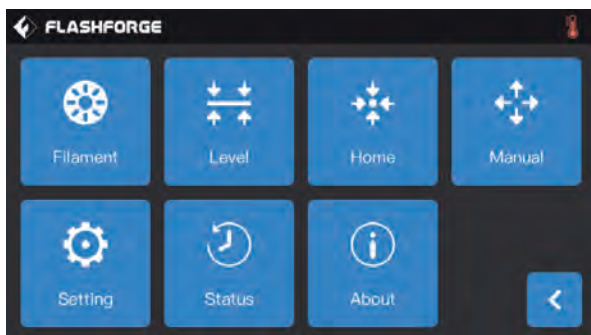

**[Tools]-[Status]**

Check left/right extruder temperature, platform temperature, filament loaded/unloaded, door opened pause and cooling fan details and extruder XYZ coordinates positions.

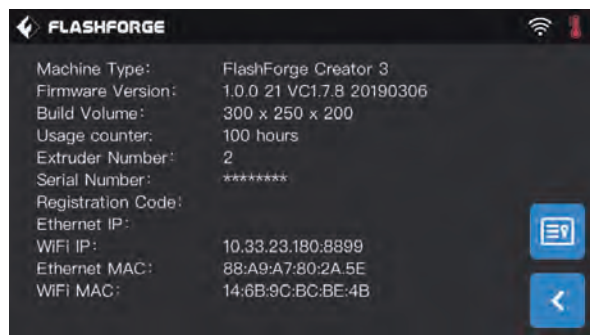
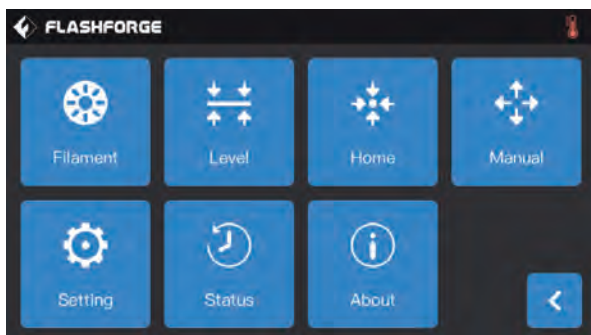

**[Tools]-[About]**



It displays the basic information about the device. for details shall be subject to the device.

Note: Please provide the printer serial number to after-sales when your printer need maintenance.

# 6. Maintenance

## 6.1 Log Copy



1. Insert USB stick, you will see  on the top right corner.
2. Tap  wait for 10 seconds, unplug USB stick.
3. Insert USB stick into computer, open USB stick folder to find log files.
4. Send log files to Flashforge customer service.

## 6.2 Maintenance and Service

Problem	Cause	Corrective Action
Extruder head building off center.	The device has lost track of extruder's exact location and is failing to build.	Send the extruder to the home position will recalibrate Creator 3. Cancel your object, clear build plate, send the extruder to the home position, and restart the object.
PLA is not extruding or sticking to the build tape properly.	This can be caused by the build plate not being leveling with the extruder head.	Leveling the build platform will align the extruder head and ensure a better object quality. Cancel your object, clear build platform, level the build platform, and restart the object.
Creator 3 froze before my object started.	Creator 3 may have received contradictory commands.	Turn power switch off, wait 30 seconds, and turn power switch on.
Spaghetti mess at end of build.	A layer of your object did not stick properly, model was saved with minimal surface area contacting the build platform, or object was built floating above the build platform with no support selected. Z axis offset may not be correct and the extruder tip is not properly spaced with the build platform.	Use the preview feature in your slicing software to see the first layer height and position. Build with supports when necessary. Contact customer service on how to calibrate the Z axis Offset.
Part only built halfway.	Filament ran out. Filament clogged during build.	Replace filament and resume build. See "No filament coming out".
No filament coming out.	Clogged extruder. Filament not properly loaded.	Contact customer service. Try running a filament change again to ensure the extruder gears have properly caught the filament.
Extruder will not home.	Limit switch wire failure	Contact customer service.
Stringy or fraying plastic layers on steep overhangs.	Object overhangs are too far apart or too steep (Less than 45 degree angle).	Build with supports.



## 6.3 Extruder Unclogging

1. Tap[Preheat],set heating temperature,then go back.
2. Tap[Tools]-[Filament]-target extruder[loading], wait for extruder to heat up. As filament starts to purge, insert the unclog tool into the extruder intake (top).
3. Clogged debris will be pushed down and will extrude from the extruder tip. You should push the unclog tool all the way down to ensure all filament is purged. You do not need to push with excessive force, as this may damage the extruder.

## 6.4 Daily Maintenance and Use Suggestion

1. Please cover the top and close the front door to prevent the device from falling into dust when not using the device.If the device has not been used for a long time, it is recommended to use the original packaging.
2. Grease moving parts regularly.For frequent users, add grease at least once every three months;For long-term nonusers, add grease at least every six months.
3. Please clean residue and other sundries in time after printing completed, avoid sundries falling affecting device use.
4. As consumable, build tape may be damaged when adhesive force declined;Please change build tape in time to avoid affecting print effect.
5. Whenever possible, it is best to locate your object in the center of the build platform. Using the best orientation for your object is critical. Ensure that your object is located on the build platform and that you are using the best orientation for building.
6. For steep overhangs (Less than 45 degree angle) it is recommended to build with support.

## 7. Support and Service

FlashForge team is on standby and ready to help you with any challenges you may have with your Creator 3. If the issues or questions are not covered in this User Guide, you can seek for solutions on our official website or contact us via telephone.

There are solutions and instructions to common issues that can be found in our knowledge base. Have a look first as most basic questions are answered there. <http://www.FlashForge.com>

The FlashForge support team can be reached by e-mail or phone between the working hours of 8:00 a.m. to 5:00 p.m. PST Monday through Saturday. In case you contact us during off-duty time, your inquiry will be answered the following business day.

**Note: Because of changing different filament the extruder maybe blockaded. It's not owing to quality issue, and outside the scope of 400 hours life. If users encounter this problem, please contact our after-sale department and finish clean work according to their instruction.**

**E-mail: [flashforge@flashforge.zohodesk.com](mailto:flashforge@flashforge.zohodesk.com) / [support@flashforge.zohodesk.com](mailto:support@flashforge.zohodesk.com)**

**ADD: No. 518, Xianyuan Road, Jinhua, Zhejiang**

**Note: Please provide serial number at the back of the printer before contacting After-sales service.**



## 前言

注：每台3D打印机在出厂前都经过打印测试，若设备喷头内存在耗材残留或打印平台有轻微划痕，均属正常现象，不影响使用。

尊敬的闪铸用户，

感谢您选择、使用闪铸科技的产品。感谢您对闪铸科技的大力支持和帮助。

闪铸科技的产品质量优质、性能上佳。为了您使用方便，请您在使用之前仔细阅读该说明书，并严格按照说明书的指示进行操作。整个闪铸科技团队时刻准备为您提供最优质的服务。在使用过程中无论遇到什么问题，请按照说明书结尾所提供的电话、邮箱与我们联系。

为了您能够更好地体验我们的产品，您还可以从以下途径获取设备的操作知识：

### (1) 说明书：

请您小心拆箱，您可以从最上层的泡沫中取出附带的Creator 3说明书。Creator 3（金刚狼三代）快速启动指南将帮助您以最快的速度熟悉设备并成功完成初次打印体验。

### (2) 闪铸官网：

闪铸中文官方网址：[www.sz3dp.com](http://www.sz3dp.com)

闪铸英文官方网址：[www.flashforge.com](http://www.flashforge.com)

您可以登陆闪铸官网寻找相关软硬件、联系方式、设备操作、设备保养等信息。

## 注意事项

请确保认真阅读以下安全提示

### 工作环境安全

- ◆ 请保证打印机的工作台面干净整洁。
- ◆ 请保证打印机工作时远离可燃性气体、液体及灰尘。（设备运行产生的高温有可能会与空气中的粉尘、液体、可燃性气体反应引发火灾）
- ◆ 儿童及未经培训的人员请勿单独操作设备。

### 用电操作安全

- ◆ 请务必将设备接地；切勿改装设备的插头。（未接地/未正确接地/改装插头必然会增加漏电风险）
- ◆ 请勿将设备暴露在潮湿或烈日的环境中。（潮湿的环境会增加漏电的风险/暴晒会加速塑件老化）
- ◆ 请勿滥用电源线，务必使用闪铸科技提供的电源线。
- ◆ 切勿在雷雨天气使用设备。
- ◆ 如长时间不使用设备，请关闭设备并拔下电源线插头。

### 个人操作安全

- ◆ 在设备运行时，请勿触碰喷头、平台等位置。
- ◆ 在打印完成时，请勿触碰喷头。
- ◆ 在操作设备时，请勿穿戴围巾、口罩、手套、珠宝装饰等容易卷入设备的物件。
- ◆ 请勿在饮酒、服药之后操作设备。

## 设备使用提示

- ◆ 切勿长时间离开正在运行的设备。
- ◆ 请勿自行对该设备进行任何改装。
- ◆ 请在设备进丝操作时，使喷头和平台的距离至少保持50mm的距离。（距离过近，有可能会造成喷头堵塞）
- ◆ 请在通风的环境下操作设备。
- ◆ 请勿利用该设备进行违法犯罪的活动。
- ◆ 请勿利用该设备制作食物储存类产品。
- ◆ 请勿利用该设备制作电器类产品。
- ◆ 请勿将打印模型放入口腔。
- ◆ 请勿用蛮力卸下打印模型。
- ◆ 请勿使用长度大于3米的网线连接本设备。

## 设备运行环境要求

- ◆ 温度：室温15-30°C为宜
- ◆ 湿度：20%-70%为宜。

## 设备放置要求

- ◆ 设备需要放置于干燥通风的环境中。设备左侧、右侧以及后侧必须要留至少20cm的距离，前侧必须要留至少35cm的空间距离。

## 设备兼容耗材要求

- ◆ 在使用该设备时，请使用闪铸提供或指定的耗材。市场上耗材鱼龙混杂，质量良莠不齐。质量低劣或不兼容的耗材很容易造成喷头堵塞及喷头损坏。

## 耗材储存要求

- ◆ 除非需要使用耗材，否则请勿轻易将耗材拆封。拆封后请将耗材储存在干燥、无尘的环境中。

## 法律禁止项目

- ◆ 请勿复制或打印法律禁止复制的任何项目。
- ◆ 根据当地法律，复制或打印以下项目一般属于违法行为：
  - 1、枪支
  - 2、复制受版权保护的作品。一些受版权保护的作品可以被部分复制以进行“合理使用”。多份复制将被视为不正当使用。艺术作品等同于受版权保护的作品。
- ◆ 以上列表仅作参考，并不包括所有内容在内。对于其完整性及准确性，本公司概不承担责任。如果您有与复制或打印某些项目的合法性相关的问题，请咨询法律顾问。

## 法律申明

- ◆ 用户无权对此使用手册进行任何修改。
- ◆ 客户若自行拆装或改造设备造成任何安全事故，闪铸科技概不负责。未经闪铸科技允许，任何人不得对该手册进行修改或翻译。本手册受版权保护，闪铸科技对本手册保留最终解释权。
- ◆ 后续因设备升级，闪铸保留对说明书修改的权利。
- ◆ 第一版（2019年3月）  
@Copyright 2019 浙江闪铸三维科技有限公司版权所有

## 服务

- ◆ 实施任何服务之前，请先拔出Creator 3电源插头。如果不这样做，则可能造成人员受伤及设备损伤。
- ◆ 只能使用闪铸科技核准的耗材和组件。使用闪铸科技所核准耗材及原装Creator 3组件以外的耗材可能导致保修无效。

# 目录

<b>1. 介绍</b>	54
1.1 Creator 3 直观图示	54
1.2 装箱清单	55
1.3 产品参数表	56
1.4 术语表	57
<b>2. 开箱和硬件安装</b>	58
2.1 开箱	58
2.2 硬件安装	61
<b>3. 首次使用安装</b>	62
3.1 调平	62
3.2 安装丝料	64
3.3 进丝和退丝	66
3.4 校准	68
3.5 网络连接	71
3.6 FlashPrint软件设置	72
3.6.1 安装软件	72
3.6.2 软件界面	72
3.6.3 设置双头打印	73
<b>4. 操作</b>	76
4.1 材料	76
4.1.1 材料兼容性	76
4.1.2 打印设置	76
4.2 开始打印	77
4.3 移除模型	80
4.4 去除支撑材料	80
4.5 摄像头连接	81
<b>5. 触摸屏介绍</b>	84
5.1 打印	84
5.2 预热	86
5.3 工具	87
<b>6. 维护</b>	95
6.1 拷贝日志	95
6.2 维护与检修	95
6.3 疏通喷嘴	96
6.4 日常保养及使用建议	96
<b>7. 帮助与支持</b>	97

# 1. 介绍

## 1.1 Creator 3 直观图示

设备视图

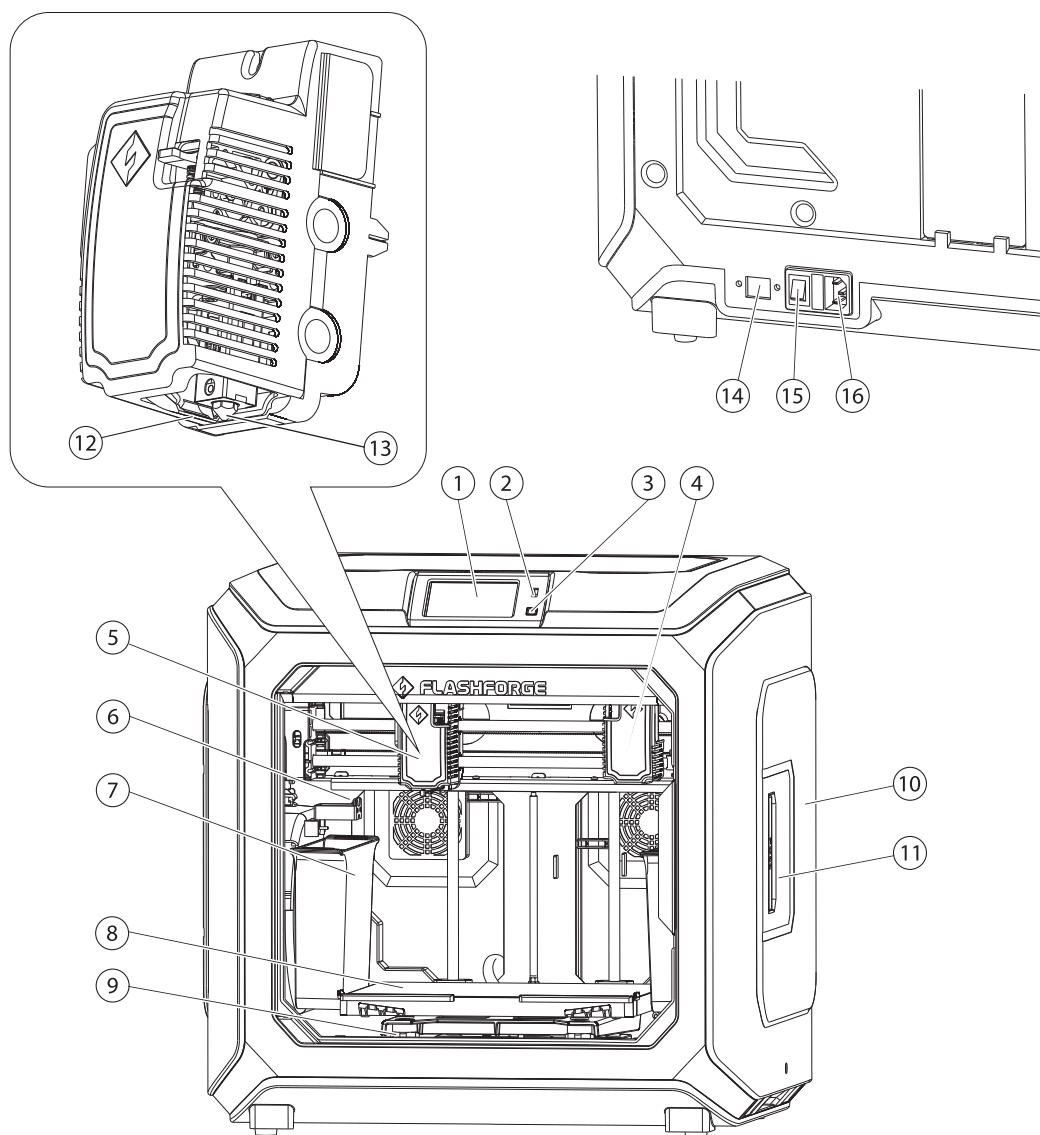

- 1、触摸屏
- 2、U盘端口
- 3、触摸屏开关
- 4、右喷头

- 5、左喷头
- 6、喷嘴刷
- 7、废料盒
- 8、打印平台

- 9、调平螺母
- 10、丝盘盖
- 11、丝盘盖把手
- 12、导风嘴

- 13、喷嘴
- 14、以太网接口
- 15、电源开关
- 16、电源线接口

## 1.2 装箱清单

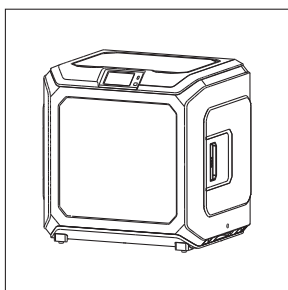

3D打印机

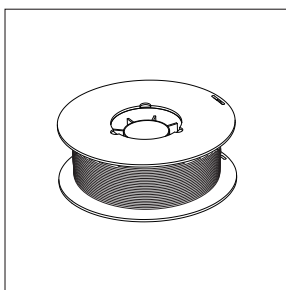

3D打印耗材

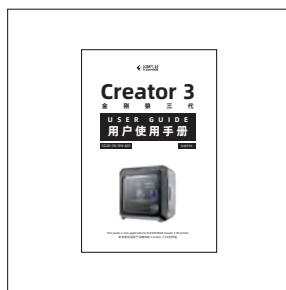

用户使用手册



售后服务卡

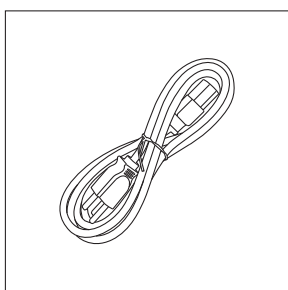

电源线

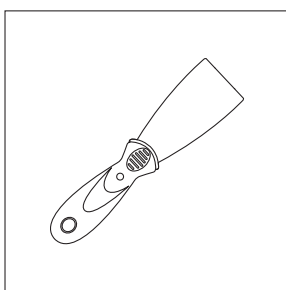

铲刀

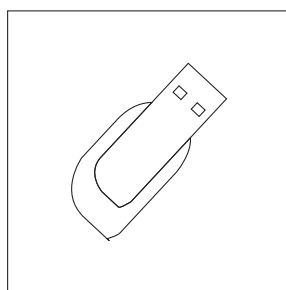

U盘

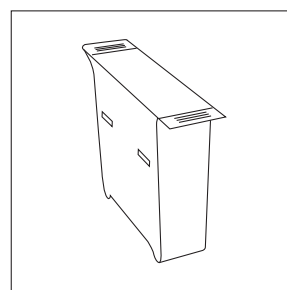

废料盒

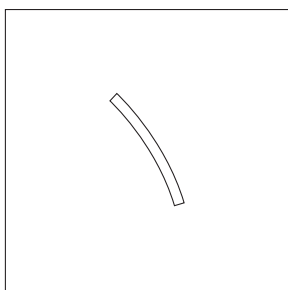

聚四氟乙烯管

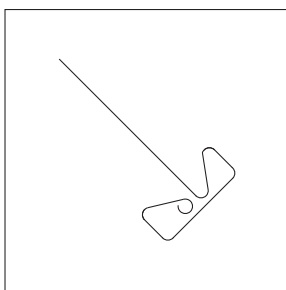

通针

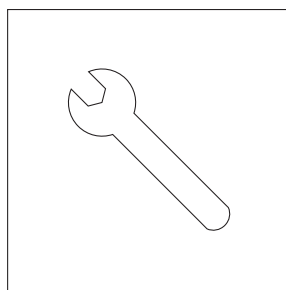

冲压扳手

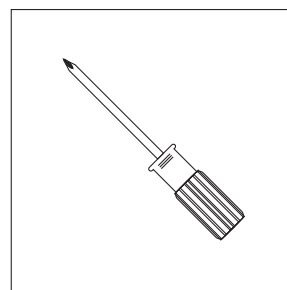

十字螺丝刀

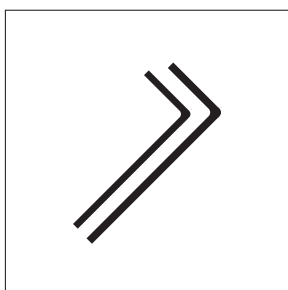

内六角扳手

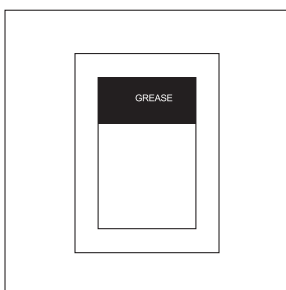

润滑脂

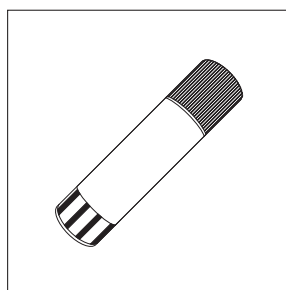

PVP固体胶

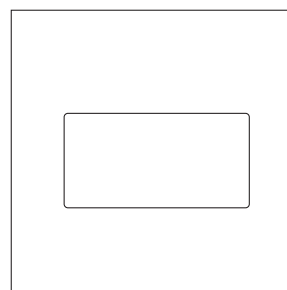

硅胶刷



## 1.3 产品参数表

打印机名称	Creator 3 (金刚狼三代)
喷头个数	2 (独立)
技术基础	丝熔制造 (FFF)
屏幕	4.5英寸彩色 IPS 触摸屏
打印尺寸	300×250×200mm
层厚	0.05 - 0.4mm
打印精度	±0.2mm
定位精度	Z 轴0.0025mm; XY 轴 0.011mm
打印材质	PLA/ABS/PC/PVA/HIPS/PETG/木塑耗材/尼龙材料
耗材直径	1.75mm (±0.07mm)
喷头直径	0.4mm
打印速度	10~150 mm/s
打印速度	10~150 mm/s
软件名称	FlashPrint
支持格式	输入: 3MF/STL/OBJ/FPP/BMP/PNG/JPG/JPEG文件 输出: GX/G文件
操作系统	Win xp/Vista/7/8/10、Mac OS、Linux
打印机尺寸	627×485×615mm
净重	40Kg
输入参数	Input: 100V-240VAC, 47-63Hz Power: 500W
数据传输	U盘、WiFi、以太网

## 1.4 术语表

打印平台	用于构建实体模型的部分。
平台贴纸	闪铸打印贴纸能够粘贴在打印平台上，目的是能够让打印模型更好地粘贴在打印平台上。当平台贴纸开始影响打印效果的时候，请及时更换。
打印体积	打印体积是指构建模型的长*宽*高。Creator 3的最大打印体积为300*250*200mm。用户不能直接构建超过该参数的模型。
调平螺母	平台支架下的三颗调平螺母用于调节打印平台和喷嘴的间距。
喷头	内含齿轮传送结构，将耗材从进丝孔导入、加热，再从喷嘴挤出。
喷嘴	构成喷头的最下部的黄铜色金属结构，经过喷头加热的耗材从该处挤出。
喷头风扇	喷头风扇用于降低喷头运作时的温度及加速耗材的凝固。
进丝孔	耗材进入喷头的入口，位于喷头顶部。
丝盘盒	放置耗材的装置，位于打印机左右侧面。
导丝管	将耗材从丝盘盒引入喷头的白色塑料细管。
PVP固体胶	打印前涂在底板表面，用于增强平台的粘性，从而减小翘边的几率。
冲压扳手	用于拆卸喷嘴时固定喷头喉管。
通针	用于疏通喷头，清理喷头中残余的耗材。
喷嘴刷	用于打印过程中擦除喷嘴废料。

## 2. 开箱和硬件安装

### 2.1 开箱



1. 剪断包装扎带，撕除缠绕膜。



2. 向上提起外包装箱。



3. 移除顶部泡棉。

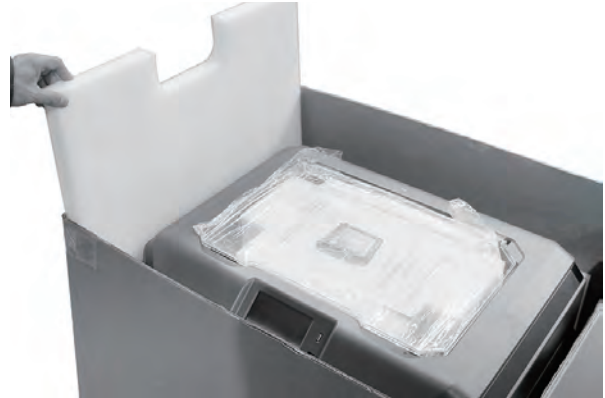

4. 移除打印机四周的泡棉。



5. 割开纸箱四角的胶带露出打印机。打开气泡袋露出打印机。



6. 移除固定顶部的胶带，打开顶盖。



7. 取出顶部配件及泡棉。



8. 移除固定打印机前门的胶带。



9. 取出内部的泡沫块，其中包含两个废料盒及两卷3D打印耗材。

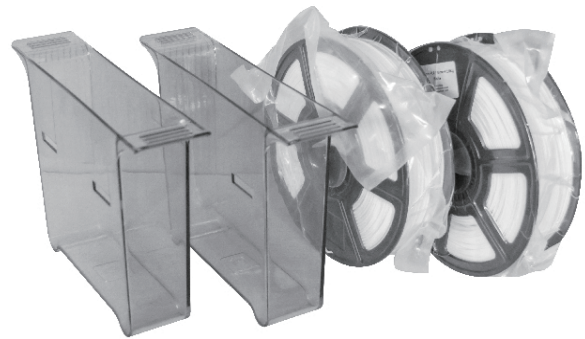

10. 移除X轴同步带和Y轴同步带上的卡扣。



11. 取出电源线，插入打印机背部的电源线接口，通电后打开电源开关。开机完成后，在触摸屏上依次点击【工具】、【手动调节】进入手动控制界面。

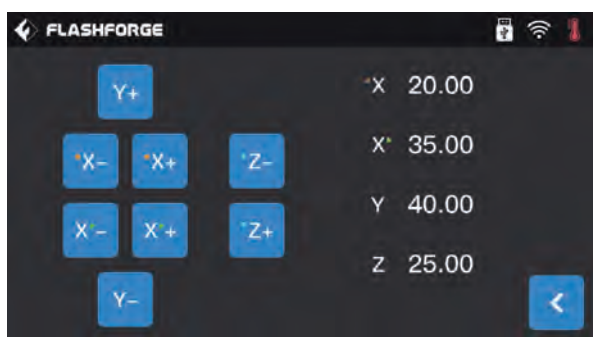

12. 持续按住【Z-】，直到打印平台上升到较高的位置，方便取出下方的泡沫块。



13. 移除打印平台下方的泡沫块。



14. 开箱完成！建议妥善保管开箱过程中移除的配件，以便日后保存或运输使用。

## 2.2 硬件安装

### 废料盒安装

取出废料盒，将废料盒挂在打印平台两侧的挂钩上即可。  
(左右两侧各一个废料盒)

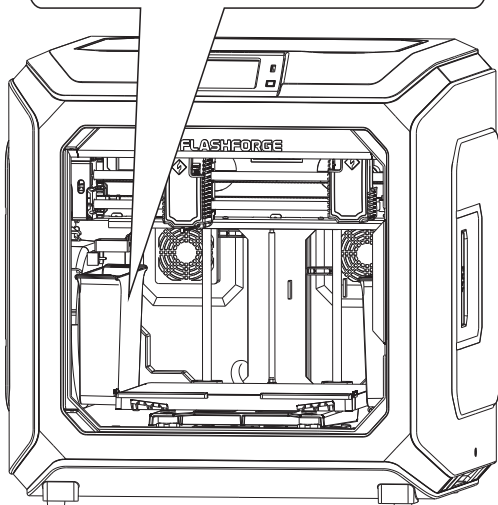
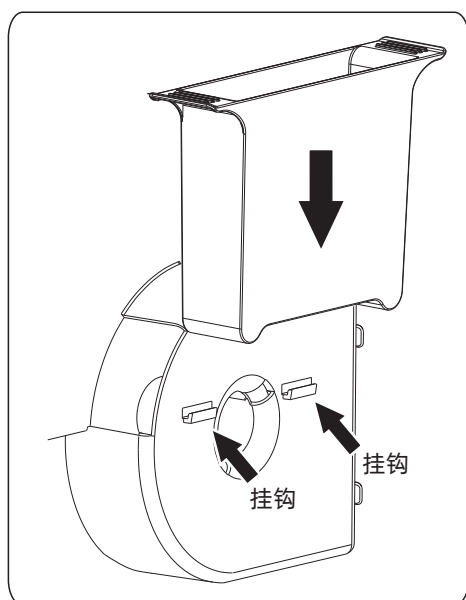
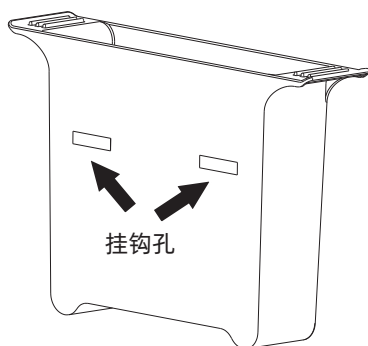

### 喷嘴刷安装

取出喷嘴刷，套在喷嘴刷安装座上即可。  
(左右两侧各一个喷嘴刷)

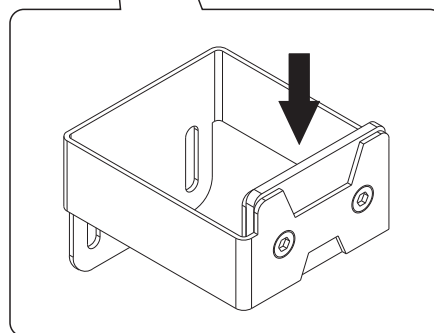
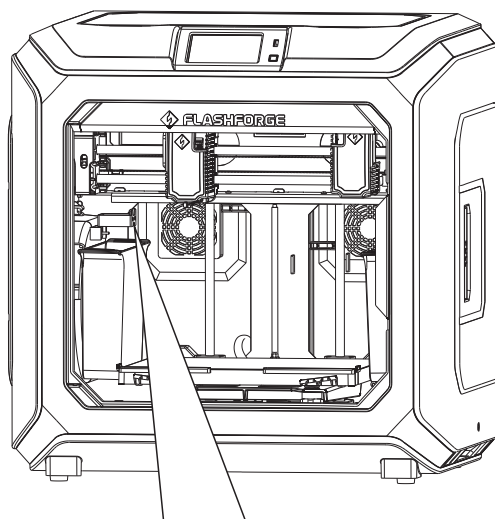

# 3. 首次使用安装

## 3.1 调平

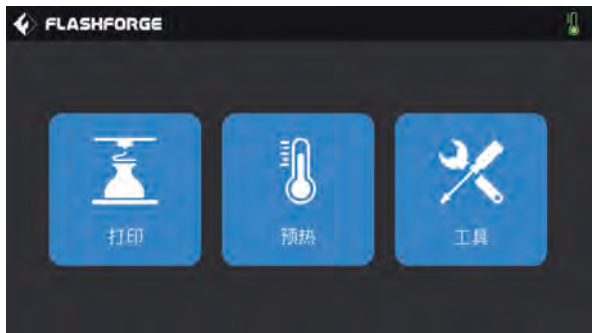

1、在触摸屏上依次点击【工具】、【调平】开始调平。



2、在喷头和打印平台停止运动后，选择使用哪个喷头进行调平。



3、选择完成后，喷头开始对第一个调平点进行距离验证。验证完成后，喷头会运动到第二个调平点进行距离验证。



4、在第二和第三个调平点的距离验证过程中，如果喷嘴和打印平台之间的距离不合适，请根据液晶屏上的提示信息进行相应的操作。验证距离合适后，喷头会运动到第三个调平点，同样根据液晶屏上的提示信息进行相应的操作。第三个调平点完成后，调平结束。

注：整个过程中若出现调平失败提示，请重复调平操作，继续按提示操作，直到【完成】即可。



## 3.2 安装丝料

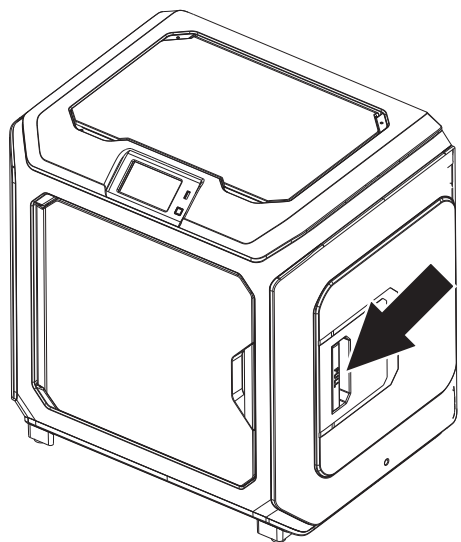

1. 打开丝盘盖。

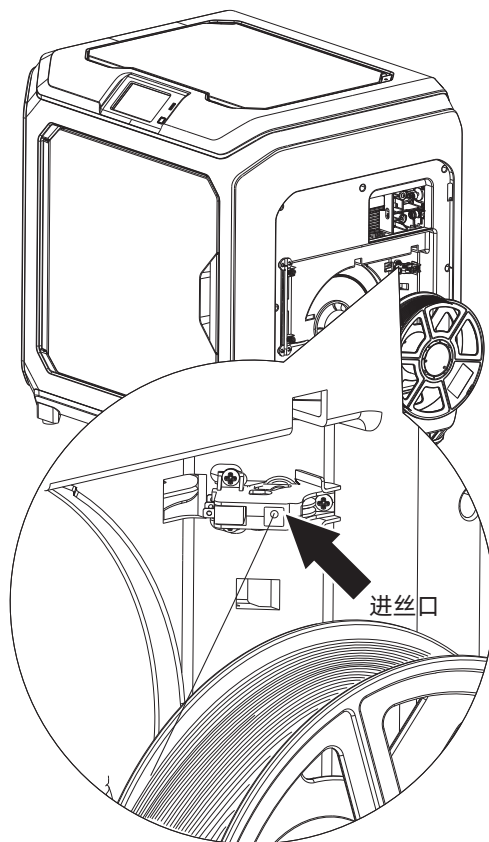

2. 取出耗材，将耗材插入进丝口中。

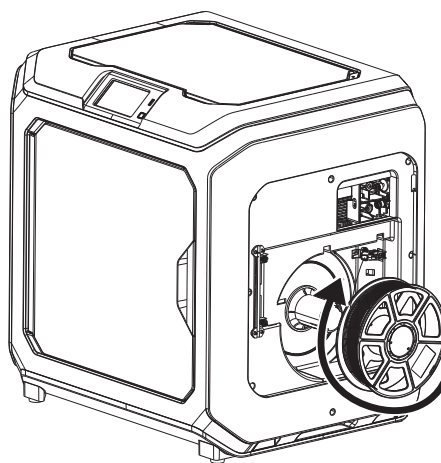
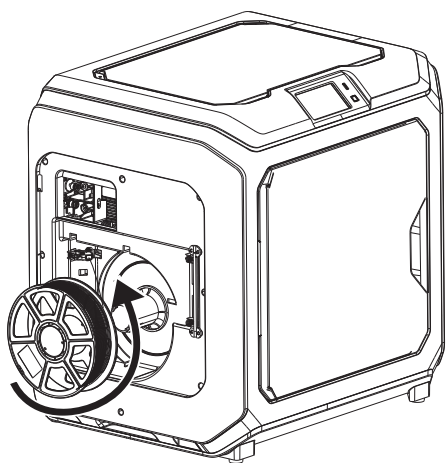

3. 注意：为方便耗材转动顺畅，请按图中所示的方向安装耗材。

安装左侧耗材时，请按逆时针方向出丝；安装右侧耗材时，请按顺时针方向出丝。

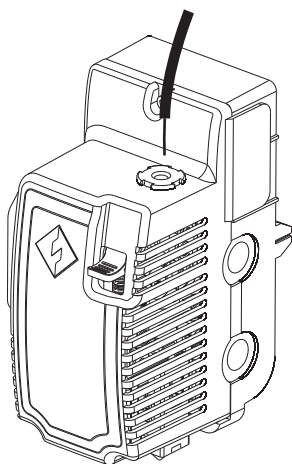

4. 持续将耗材送入进丝口，直到耗材从导丝管穿出。

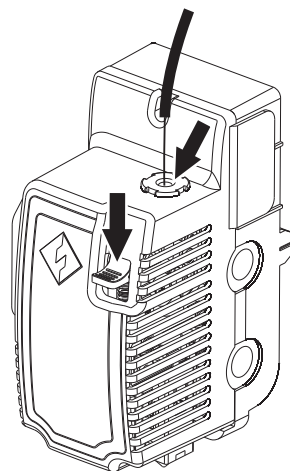

5. 按下喷头前方的进丝压板，将耗材垂直插入喷头，直到无法继续插入。松开进丝压板。

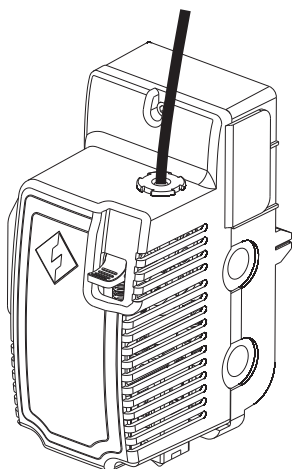

6. 将导丝管插入喷头进丝孔中固定。

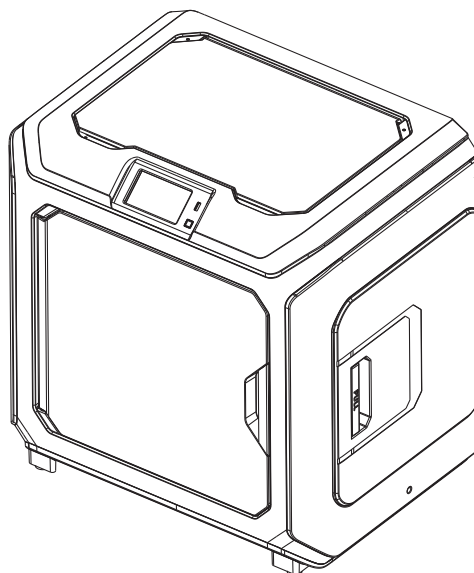

7. 最后将丝盘固定在丝盘架上，盖上丝盘盖。

### 3.3 进丝和退丝

#### 【进丝】



1. 依次点击触摸屏【工具】-【换丝】-目标喷头【进丝】，等待喷头升温。



点击温度值，将会弹出温度值修改窗，默认进丝温度为220°C。需要进丝ABS/PC 等较高温度的材料时，请点击修改温度值。



2. 将丝料盘安装在机器丝料盘安装位上，将丝料穿过丝料检测组件；手动送丝通过长长的白色耗材导丝管，直至耗材导丝管另一端出现耗材。

- 当喷头加热到目标温度，左手向下压耗材压板，右手将耗材插入喷头进丝口，直至感受到送丝轮向下送耗材的感觉。放开耗材，并将白色耗材导丝管插入喷头进丝口。
- 等待喷嘴挤出均匀的耗材。若为换丝，请等待耗材颜色一致后，再停止进丝。

注意：若喷头长时间未出丝，请检查安装耗材时是否正确将耗材插入喷头底部。

## 【退丝】



- 依次点击触摸屏【工具】-【换丝】-目标喷头【退丝】，等待喷头升温。

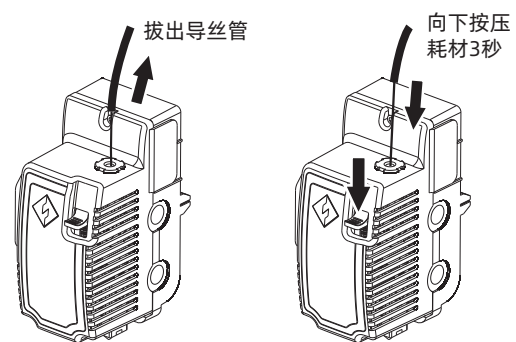

- 当喷头加热到目标温度，等待喷嘴均匀挤出耗材。此时，左手向下压耗材压板，右手拔出白色耗材导丝管，将耗材迅速向上拔出。退丝完成。

## 3.4 校准

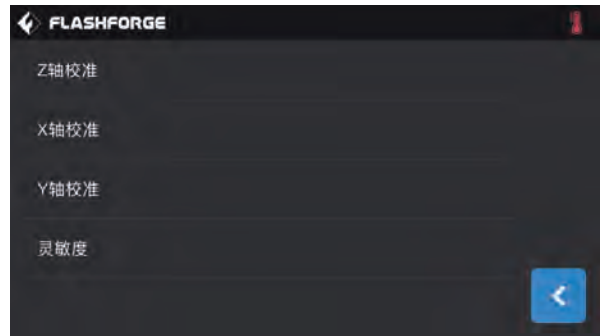

依次点击触摸屏【工具】-【设置】-【校准】，进入校准页面。

### 【Z轴校准】

1、Z轴校准前，请先进行调平。调平请参见【62】页。



- 2、点击触摸屏【Z轴校准】，等待喷头和平台Z轴校准。校准过程中，不要中断。
- 3、等待自动校准完成即完成Z轴校准。

### 【灵敏度】

表示喷头中传感器的灵敏度，数值越高灵敏度越低；

当灵敏度过强时，可能引起z轴校准异常报错，当遇到设备经常提示z轴校准异常时，请调节一下传感器的灵敏度；将数值增大。

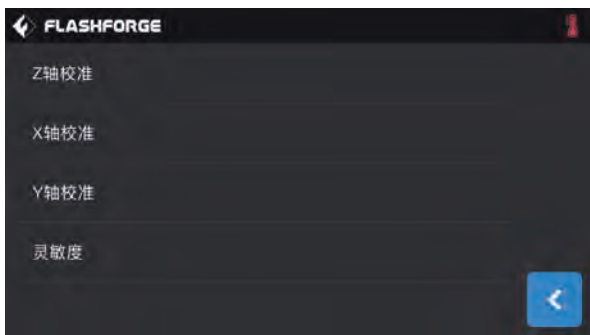

### 异常状态:

当Creator 3 出现打印时不停的提示“请重新校准”或“Z轴错误”、以及手动调节时平台与喷头接触了还在继续向上移动时。您的打印机压电片可能已经出现故障了。请调整传感器的灵敏度。

- 1、压电片过于灵敏会导致打印前校准z轴时平台运行到中途，未触碰到喷嘴就停止，说明传感器过于灵敏则灵敏度数值应调大。
- 2、压电片不灵敏会导致打印前校准z轴时平台已经触碰喷嘴却仍未停止，持续向上运动，说明传感器不灵敏则灵敏度数值应调小。
- 3、正常数值推荐为20-25。

### 【X轴校准】

通过比对两个喷头在X轴方向打印的直线是否重合，判断两个喷头在同一条X轴上。

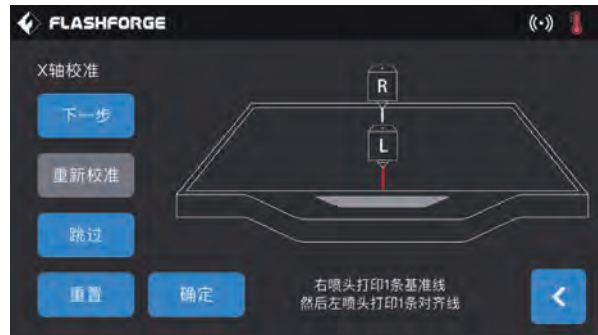

- 1、点击触摸屏【X轴校准】，等待两个喷头加温；加温到目标温度，两个喷头依次打印一条直线。打印完毕，检查两条线是否重合；同时，触摸屏弹出确认窗口。

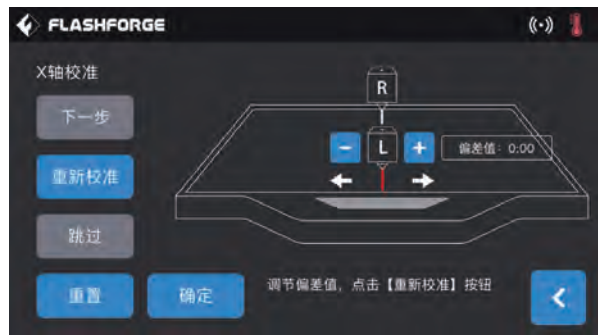

- 2、当两条线未重合时，点击下一步，将会有提示弹窗操作，喷头向左或向右进行偏差调整。  
下一步：表示打印后进行下一步判断提示并操作。  
重新校准：左右喷头重新各打印1条线。  
跳过：用户已知两条线不重合，不需要进行下一步的提示，可直接点击跳过，进行调节值偏差设置。  
确定：保存调节的偏差值。  
返回：直接退出校准页面对当前所做的操作不保存数据。

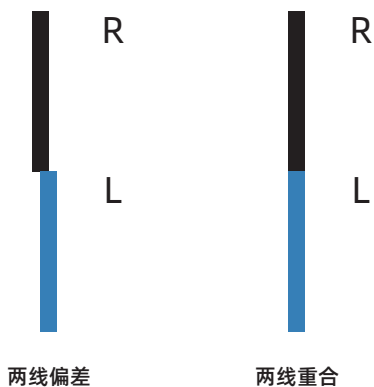

出现如图所示的情况，请根据屏幕提示点击+-图标，以左喷头为调节喷头，估算偏差值。输入估算值后点击【重新校准】；重复上述步骤，直至两条线重合。



3、若两条线完全重合，点击【是】，X轴校准完成。

### 【Y轴校准】

通过比对两个喷头在X轴方向打印的直线是否重合，判断两个喷头在同一条Y轴上。

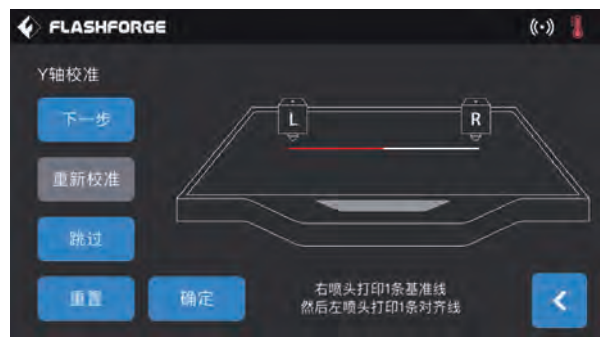

1、点击触摸屏【Y轴校准】，等待两个喷头加热；加热到目标温度，两个喷头依次打印一条直线。打印完毕，检查两条线是否重合；同时，触摸屏弹出确认窗口。

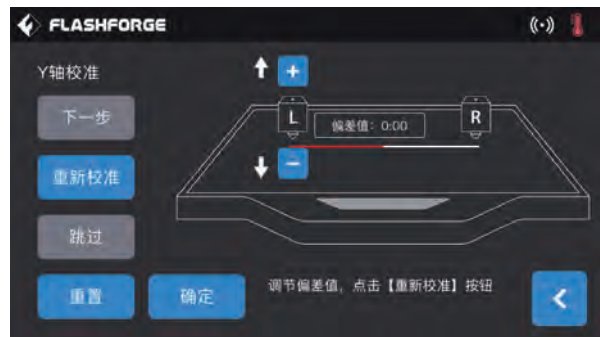

2、若两条线完全重合，点击【是】，Y轴校准完成。若两条线没有完全重合，点击【否】；根据实际情况调整喷头位置。调整结束后，清理打印平台上的耗材，并点击【重新校准】；重复上述步骤，直至打印的两条直线完全重合。

## 3.5 网络连接

### · 有线网络连接

将网线插到设备的网线插口，屏幕右上角出现  图标，则表明设备已经成功连接上网络。

### · WLAN网络连接

在设备触摸屏的主界面依次点击【工具】-【设置】-【WLAN网络】，开启无线局域网，选择需要连接的网络。屏幕右上角出现  图标，则表明设备已经成功连接上网络。

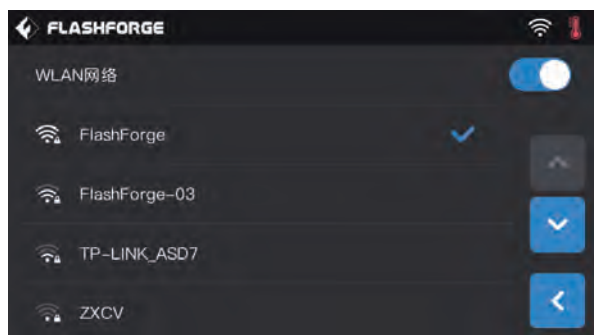

### · WLAN热点连接



1、在设备触摸屏的主界面依次点击【工具】-【设置】-【WLAN热点】，开启设备热点。您可以自由设置热点的名称和密码。屏幕右上角出现  图标，则表明设备已经成功开放热点。



2、使用笔记本电脑搜索到您设置的热点，并点击连接，输入密码。

建议：如果同时拥有多台Creator 3，请进入WLAN热点设置中分别修改热点名称。



## 3.6 FlashPrint软件设置

### 3.6.1 安装软件



FlashPrint

#### 1、软件获取

您可以选择以下2种方式获取FlashPrint软件安装包：

方式1：将工具包中的U盘插入电脑，找到最新的软件安装包。

方式2：打开浏览器输入www.sz3dp.com进入闪铸中文官网，进入首页后将鼠标悬停在技术支持选项上并在下拉菜单中点击下载中心，选择您需要的软件版本点击Download进行下载。

#### 2、软件安装启动

下载后，开启安装程序并按照提示完成安装。安装完成后，启动FlashPrint程序开始使用。

### 3.6.2 软件界面

在FlashPrint菜单栏【打印】-【机器类型】中选择 Creator 3机型，将显示主界面。以下是界面概览：

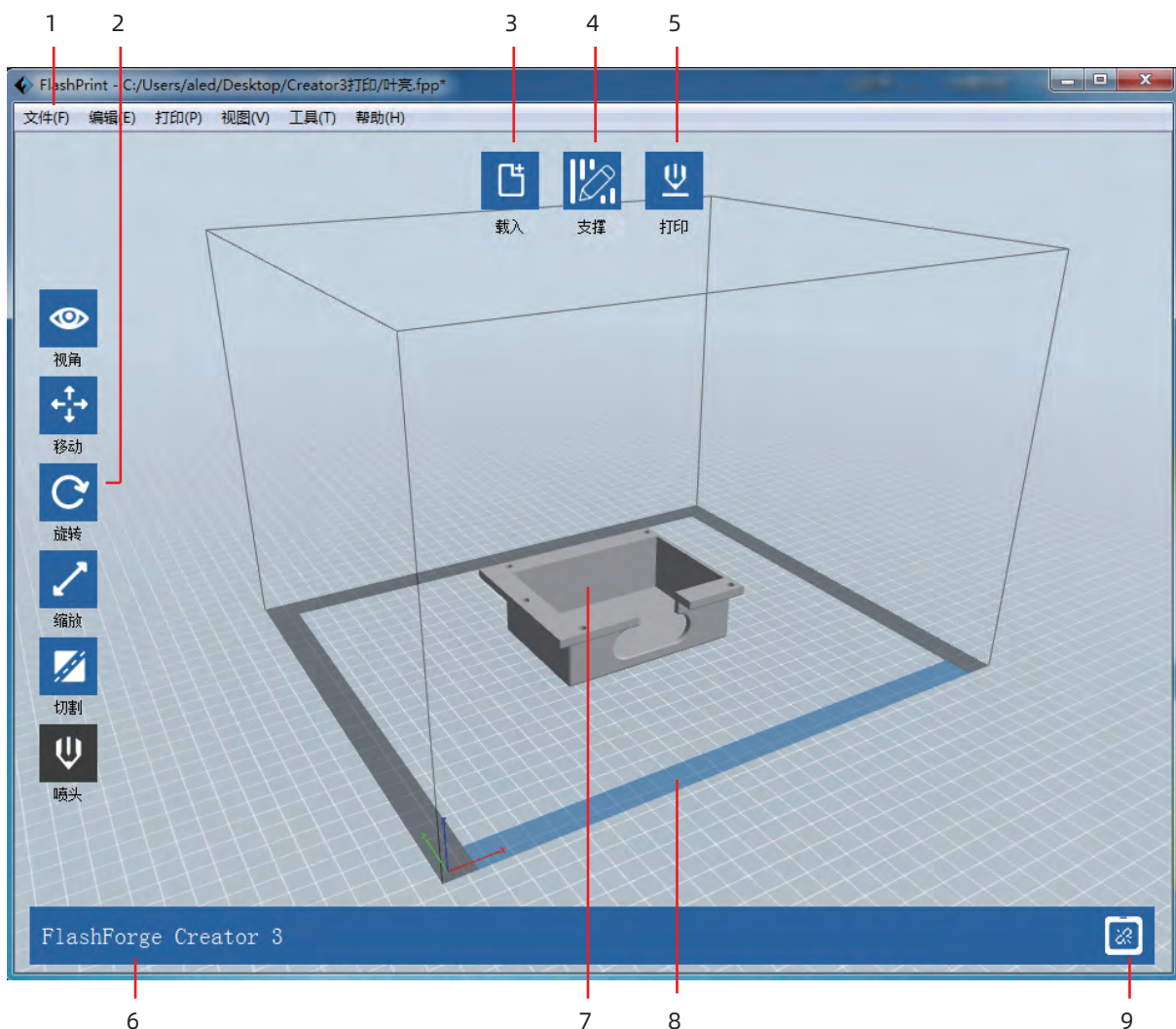

1. 菜单栏

2. 调整区域

3. 载入模型文件

4. 支撑设置

5. 打印

6. 打印机型号

7. 3D模型

8. 打印平台正面方向

9. 打印机连接状态

### 3.6.3 设置双头打印

金刚狼3默认左喷头作为支撑材料喷头，右喷头为打印喷头，当打印单色模型时，若用户未进行设置，自动使用右喷头作为打印的喷头，打印有如下模式可设置：

在专家模式下：

- 1、载人模型；
- 2、选择支撑类型，点击【支撑】>【支撑选项】>【线性】，同时勾选【与底板接触】，点击【确定】；
- 3、自动添加支撑，点击【支撑】>【自动支撑】，返回并保存；
- 4、点击【打印】，进入参数配置页面；
- 5、常规页面，选择配置材料，比如 Creator 3 PLA；
- 6、常规页面，点击【适配可溶性支撑材料】>【PVA】>【适配】；
- 7、点击【保存配置】。

点击【文件】-【偏好设置】-【打印】-选择专家模式（使用creator3 建议使用专家模式设置细节参数）



在基本模式下：

- 1、载人模型；
- 2、选择支撑类型，点击【支撑】>【支撑选项】>【线性】，同时勾选【与底板接触】，点击【确定】；
- 3、自动添加支撑，点击【支撑】>【自动支撑】，返回并保存；
- 4、点击【打印】，进入参数配置页面；
- 5、推荐使用材料右为结构丝料，材料左为可溶性支撑丝料；
- 6、方案中勾选围墙，其他系统默认；
- 7、点击【保存配置】。

点击【文件】-【偏好设置】-【打印】-选择基本模式（该模式为基础操作）



### 镜像/复制模式

当需要打印两个相同或者镜像的模型，可以选择镜像/复制模式，在此些模式下，左右喷头将同时打印模型。（注意镜像/复制模式下，模型X轴大小仅支持小于133mm 的模型）

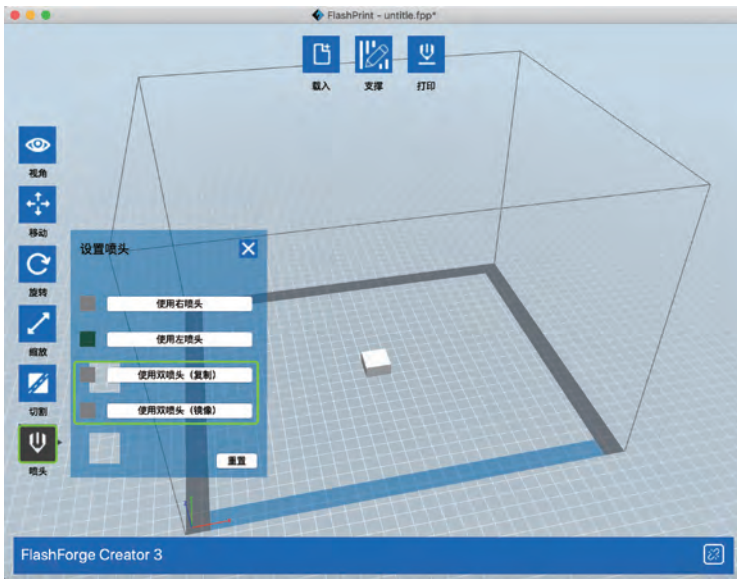

点击【喷头】- 选择模式

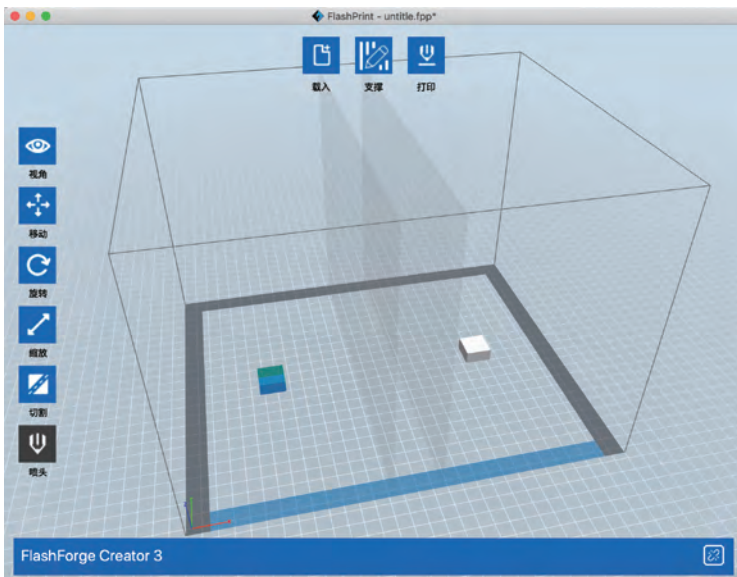

呈现镜像或复制状态后，点击打印。

# 4. 操作

## 4.1 材料

### 4.1.1 材料兼容性

Creator 3搭配两个独立喷头。可用于打印PLA、ABS、PETG、尼龙、PC、HIPS和PVA。默认Creator 3的左喷头打印支撑耗材。

独立双头挤出材料组合情况，请参见下表。

#### 可溶性耗材组合：

左喷头	右喷头
PVA	PLA
PVA	NYLON
HIPS	ABS
HIPS	ASA
HIPS	PC
HIPS	PETG
HIPS	HIPS

PVA: 可溶解于水

HIPS: 可溶解于柠檬烯

#### 非可溶性耗材组合：

左喷头	右喷头
PLA	PLA
ABS	ABS
ASA	ASA
PC	PC
PA	PA
PETG	PETG
PA-CF	PA-CF
PA-GF	PA-GF

注：金刚狼3可打印尼龙碳纤维，尼龙玻璃纤维，但由于喷嘴非高强度材料，将会对喷嘴造成磨损，预计打印1卷1kg 尼龙碳纤维耗材需更换喷嘴。且必须匹配强力挤出机使用，标配设备非强力挤出机。

虽然 Creator 3 采用的是开放式材料系统，我们还是建议在打印机上使用Flashforge 材料。所有 Flashforge 材料均已经过专门测试，并在FlashPrint 中拥有优化的配置文件，可确保最佳打印效果。

#### PVA/ PA耗材的存储

PVA耗材由于是水溶性的，有较强的吸水性，耗材吸水会软化，容易打印失败。打印时也将PVA耗材放置在干燥盒中。PA/PVA存储都需要密封干燥存储。

### 4.1.2 打印设置

为获得最佳效果，每种材料都需要不同的设置。

如果使用 FlashPrint 准备模型，在选择正确的喷头和材料的情况下，这些设置将自动正确设定。

#### 耗材参数的适配性

不同耗材品牌对应材料特性有不同差异，因此使用creator 3 时建议使用专家模式，对参数进行微调确保有较好的打印质量。

- 第一层层高加厚，加大第一层出丝量有利于第一层的粘附；
- 打印 PLA 小模型（或环境温度高于25°C）时请设置45°C的底板温度；
- 打印 PLA 大模型（或环境温度低于10°C）时请设置70°C的底板温度；
- 使用PVA支撑时，建议支撑速度降低至40%。

对于 Creator 3 支持的所有材料，在开始打印前，还建议在打印平台板上涂一层薄薄的胶（使用配件箱中的胶棒）。这样可确保打印成品很好地附着在打印平台板上。

## 4.2 开始打印

首次打印前，请在说明书的指引下正确地完成调平、进丝和校准

### · 内存卡打印

依次点击触摸屏首页【打印】-内存卡图标，选择已经存储在设备内存卡内的打印文件。选择该方式的打印的文件，不支持文件复制。

### · U盘打印

依次点击触摸屏首页【打印】-U盘图标，选择已经存储在U盘内的打印文件。选择该方式的打印的文件，支持文件复制到设备内存卡内。

### · 网络传输打印

网络传输打印方法无论使用有线网络连接还是无线网络连接，其方法仅限于设备和电脑在同一个局域网内。

1、请参照【71】页网络连接方法，连接成功。

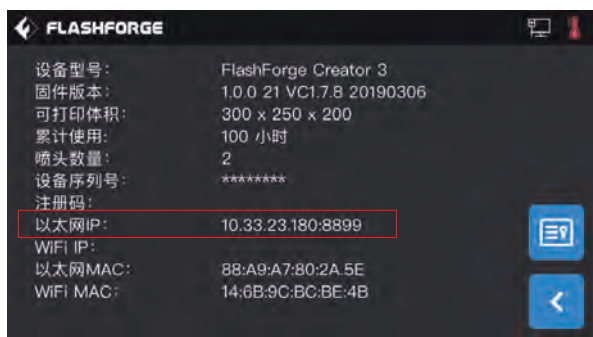

2、在主界面依次点击【工具】-【关于】，查询并记录设备以太网IP地址：10.33.23.180（示例仅供参考，以本地获取的IP地址为准）。

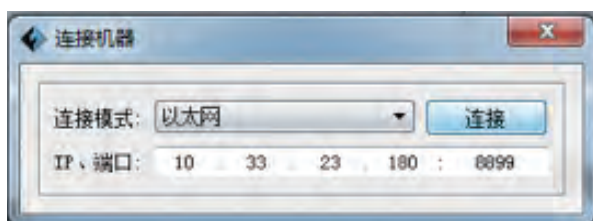

3、在电脑上依次点击FlashPrint菜单栏【打印】-【连接机器】。在弹窗的下拉窗口中，选择【以太网】连接，输入10.33.23.180:8080（示例仅供参考，以本地获取的IP地址为准）。

连接成功后，在FlashPrint界面的右下角显示连接  图标。

## · 热点连接打印

1、请参照【71】页热点连接方法，连接成功。

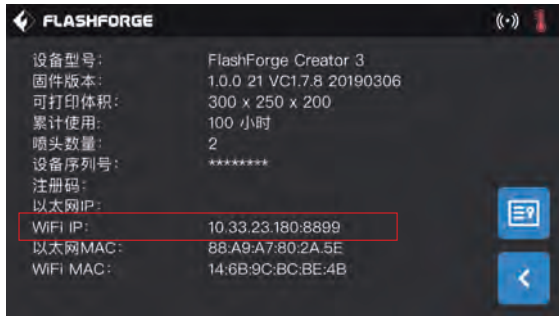

2、依次点击触摸屏【工具】-【关于】，查询并记录设备WiFi IP地址：10.33.23.180（示例仅供参考，以本地获取的IP地址为准）。

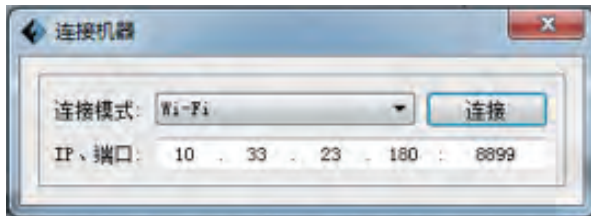

3、在电脑上依次点击FlashPrint菜单栏【打印】-【连接机器】。在弹窗的下拉窗口中，选择【WiFi】连接，输入10.33.23.180:8080（示例仅供参考，以本地获取的IP地址为准）。连接成功后，在FlashPrint界面的右下角显示连接  图标。

## · 闪铸云打印

- 1、打开WiFi或插入网线，连接网络；
- 2、点击【工具】、【设置】、打开云连接开关；
- 3、打开浏览器，进入闪铸云网站 <https://cloud.sz3dp.com> 进行以下操作。

登录

邮箱

密码

记住密码

登录

忘记密码 注册

① 在闪铸云 <https://cloud.sz3dp.com> 上注册闪铸云账号并登录。

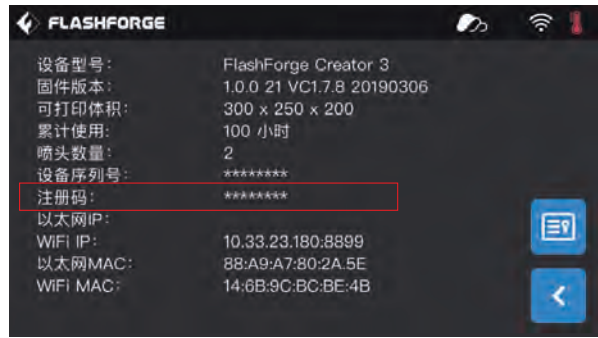

② 在闪铸云【我的打印机】界面点击【添加打印机】填入打印机名称和注册码（设备打开云连接后，请在【工具】-【关于】查看注册码）。

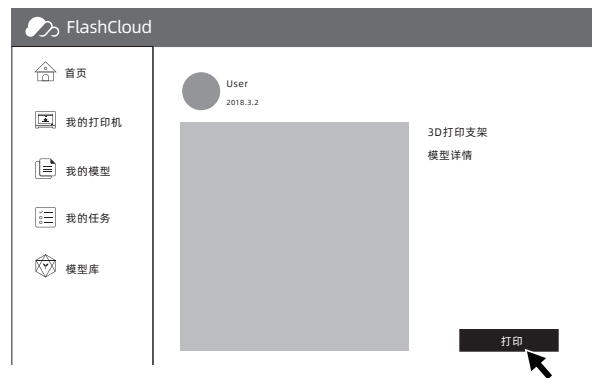
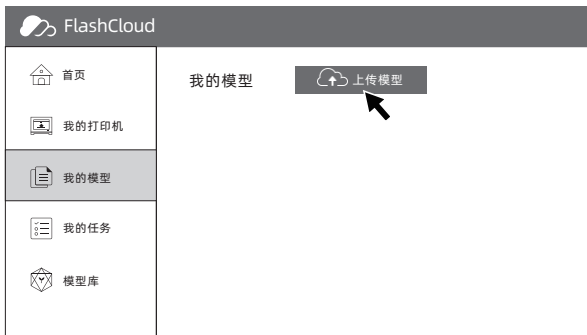

4、在模型库中选择一个模型，或上传自己的模型文件（STL文件），点击【打印】，进入模型简易编辑界面。

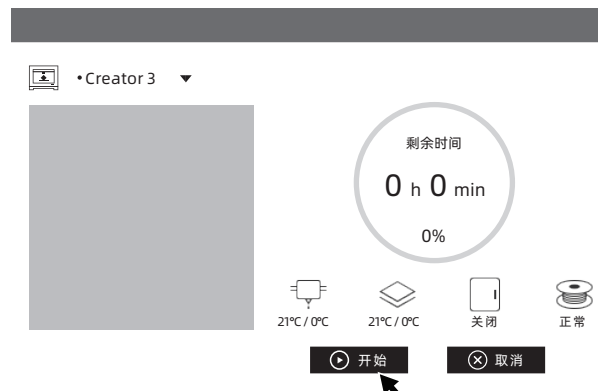
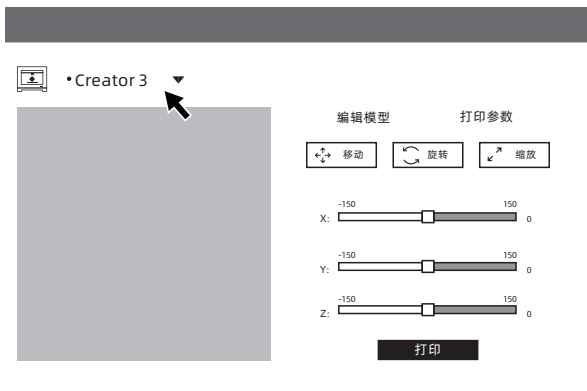

5、在打印机名称的下拉菜单中，可以选择希望执行本次打印任务的打印机。（打印机必须被添加进我的打印机）

6、最后点击开始，被选中的打印机会自动开始执行本次打印操作。

注：出于安全考虑，一台打印机供一个闪铸云账号添加使用，如有需要更换闪铸云账号，请在原账号下删除该台机器。



## 4.3 移除模型

**警告！**使用手动工具从打印平台上移除模型时，请注意您的身体位置。从打印平台移除模型时，突发性工具打滑和身体位置不当可能导致人员受伤。

**当心：**移除模型时，请勿刮花打印平台。打印平台中的划痕将会导致模型创建错误。

### · 模型冷却

在打印平台上直接打印而没有使用胶粘剂，只需让打印平台板和模型自行冷却，随着材料自身的冷却收缩，可以从打印平台板上轻松取下打印成品。

### · 使用铲刀

冷却后模型依然附着在打印平台板上，可以使用铲刀取下打印成品。保持铲刀与打印平台平行，从模型底部轻微插入，稍微用力即可取下模型。

如有需要，可从打印机中取出打印平台板，再用铲刀把模型从打印平台板上取下。

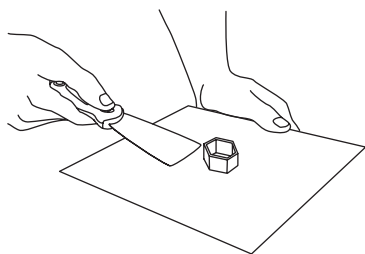

### · 使用水

如果打印时在打印平台上使用了胶粘剂，并且上述两种方法都无效，请将打印平台从设备中取出，用温水冲打印平台板的打印面，以便胶溶解。

胶溶解后，就可以轻易地取下模型。如果使用了 PVA，请将打印平台板和模型浸入水中以溶解 PVA。这样可以更容易地取下模型。

## 4.4 去除支撑材料

使用PVA为支撑材料的模型需要一些后续处理，以去除PVA支撑材料。这可以通过将PVA溶解于水中的方式完成。

### 1、将模型浸泡水中

将带有PVA的模型放入水中，可让PVA缓慢溶解。您可以利用以下几种方法加快溶解过程：

- 使用较热的水可以减少溶解的时间。如果结构材料是PLA，请确保水的最高温度不超过35度，以避免PLA变形。如果是尼龙，请勿超过50度，以防止燃烧。
- 使用搅拌/流动的水可显著地减少溶解时间。当水流动时，PVA溶解得更快。
- 先将模型在水中浸泡约10分钟，之后可以用钳子去除大部分的支撑，再把模型放回水中，这样可以使PVA更容易溶解

### 2、用水冲洗

在 PVA 支撑完全溶解后，用水冲洗模型以去除剩余的 PVA。

### 3、晾干模型

让模型完全干燥，如有必要再对模型进行额外的后处理。

### 4、废水处理

由于PVA可生物降解，因此事后很容易处置废水。当废水管道和废水处理长连接时，废水可通过废水管道排出。处置过废水后，用热水冲30秒，以去除排水管中多余的PVA，避免长期堵塞。

水可以重复用于浸泡多个模型，不过可能会增加溶解时间。因此建议使用新水以达到最快速效果。

## 4.5 摄像头连接

在使用摄像头前，请取掉位于摄像头前部的盖子。

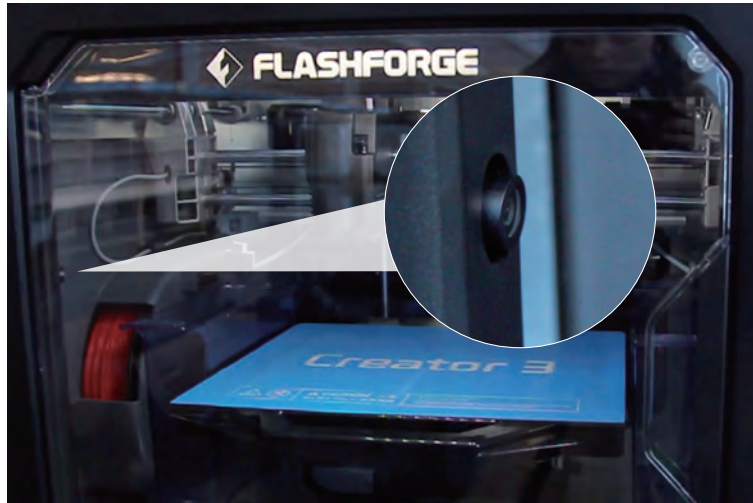

### · WLAN热点连接摄像头



1、请参照【71】页热点连接方法，连接成功。



2、依次点击触摸屏【工具】-【设置】-【关于】，查询并记录设备WiFi IP地址：10.33.23.180（示例仅供参考，以本地获取的IP地址为准）



3、电脑成功连接同一局域网内的WLAN热点。



4、打开浏览器，输入并前往地址10.33.23.180:8080（示例仅供参考，以本地获取的IP地址为准），点击【Stream】即可查看Creator 3内摄像头画面。

注：使用电脑、手机、平板电脑的浏览器打开【Stream】的结果是一致的。

## · WLAN网络连接摄像头

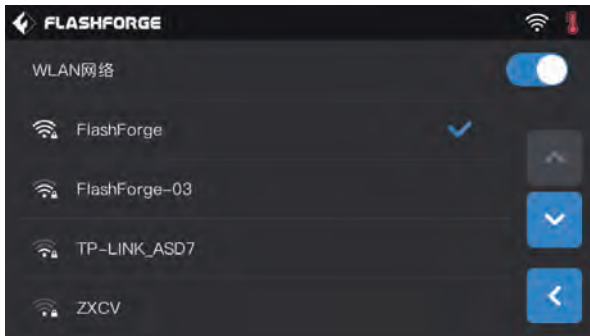

1、在设备触摸屏的主界面依次点击【工具】-【设置】-【WLAN网络】，开启WLAN网络连接按钮并连接网络。

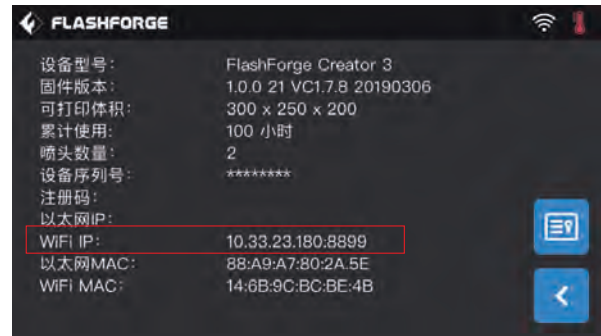

2、在主界面依次点击【工具】-【设置】-【关于】，查询并记录设备WIFI IP地址：10.33.23.180（示例仅供参考，以本地获取的IP地址为准）



3、打开浏览器，输入并前往地址10.33.23.180:8080（示例供参考，以本地获取的IP地址为准），点击【Stream】即可查看Creator 3内摄像头画面。

注：使用电脑、手机、平板电脑的浏览器打开【Stream】的结果是一致的。

## · 闪铸云连接摄像头

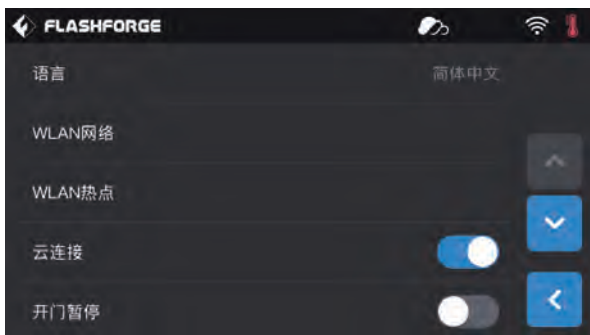

1、打开WIFI或插入网线，连接网络；  
2、在主界面依次点击【工具】-【设置】，打开云连接开关。



3、在闪铸云 <https://cloud.sz3dp.com> 上注册闪铸云账号并登录。

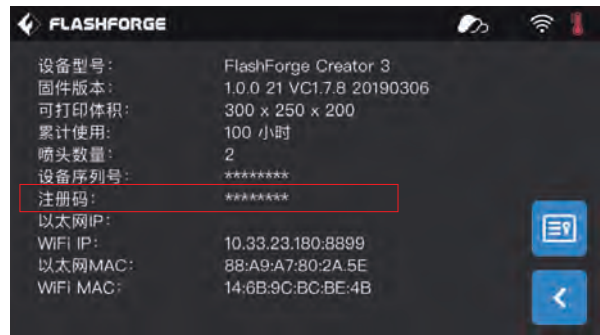

4、在闪铸云【我的打印机】界面点击【添加打印机】填入打印机名称和注册码（设备打开云连接后，请在【工具】-【关于】查看注册码）。



5、点击打印机，进入打印机详情页。

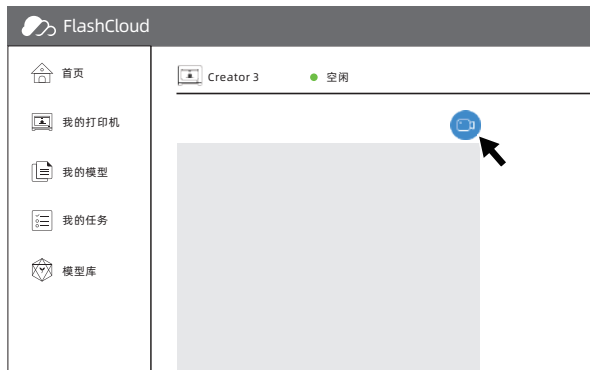

6、点击箭头所指位置的摄像头图标，摄像头开始工作。

注：请确保打印机已正确连接网络，云连接功能处于打开状态，并且打印机处于摄像头功能打开状态下。

# 5. 触摸屏介绍

## 5.1 打印

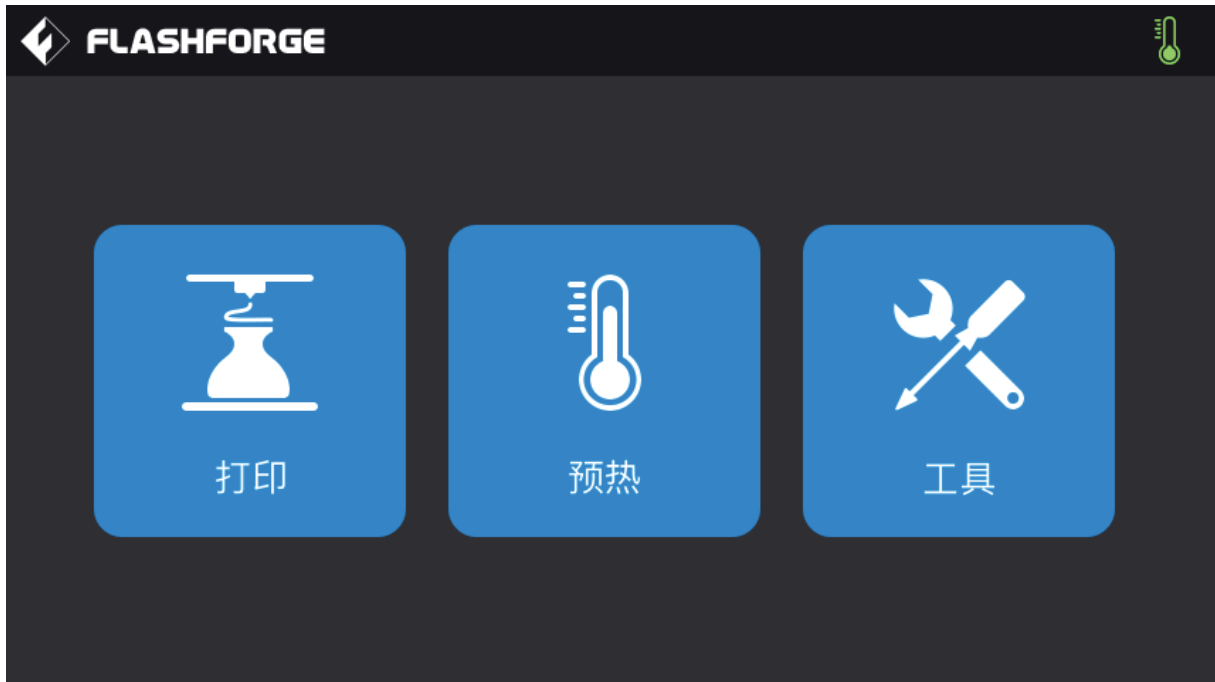

点击【打印】，选择需要打印的模型

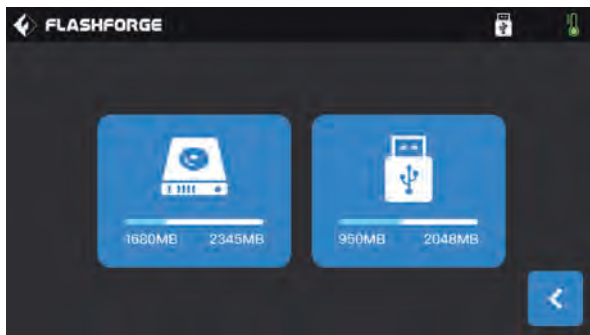

选择读取打印文件的路径

- 1、从打印机本地存储卡中读取；
- 2、从外接U盘中读取打印文件；



在文件列表中选择打印文件

1. 打印：开始打印；
2. 复制：将U盘中的文件复制到打印机本地存储卡（选择本地存储卡打印时此功能不可用）；
3. 删除：删除此打印文件；



#### 开始打印界面

- 1、停止：取消此次打印工作；
- 2、暂停/开始：暂停打印/开始打印；
- 3、更多：打印过程中可实时查询或更改：灯带状态、换丝设置、打印进度、打印速度、丝料使用量、打印时间和Z轴坐标；
- 4、左/右喷头温度、打印平台温度：打印过程中可进行修改；



#### 修改左/右喷头温度和底板温度

喷头温度达到目标温度值，出现下划线后，点击喷头温度数值，选中数字框，通过点击“-”“+”修改设定喷头温度数值，点击【是】保存设定值；点击【否】取消设定。



#### 打印过程中点击更多按键

可实时查询或更改：换丝设置、关灯设置、打印详细信息（打印速度、丝料使用量、打印时间、Z轴坐标）。

- 1、换丝：打印中途需要换丝时可点击换丝按键（暂停打印后该功能可用）；
- 2、关灯：打印过程中可通过点击关灯按键实时打开或关闭灯带；
- 3、详细信息：
  - a、打印速度：打印过程中可点击设置打印速度数值；
  - b、丝料使用量：查看打印模型丝料使用量（单位：米）；
  - c、打印时间：查看打印时间；
  - d、Z轴坐标：查看Z轴坐标；
  - e、返回：取消更多命令，返回打印界面；

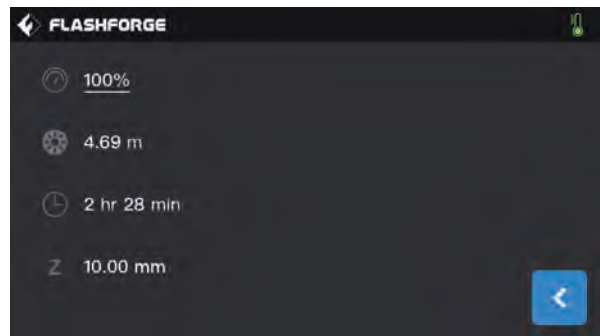

#### 修改打印速度

开始打印后，点击打印速度数值，选中数字框，通过点击“-”“+”修改设定打印速度数值，点击是保存设定值；点击否取消设定。

## 5.2 预热

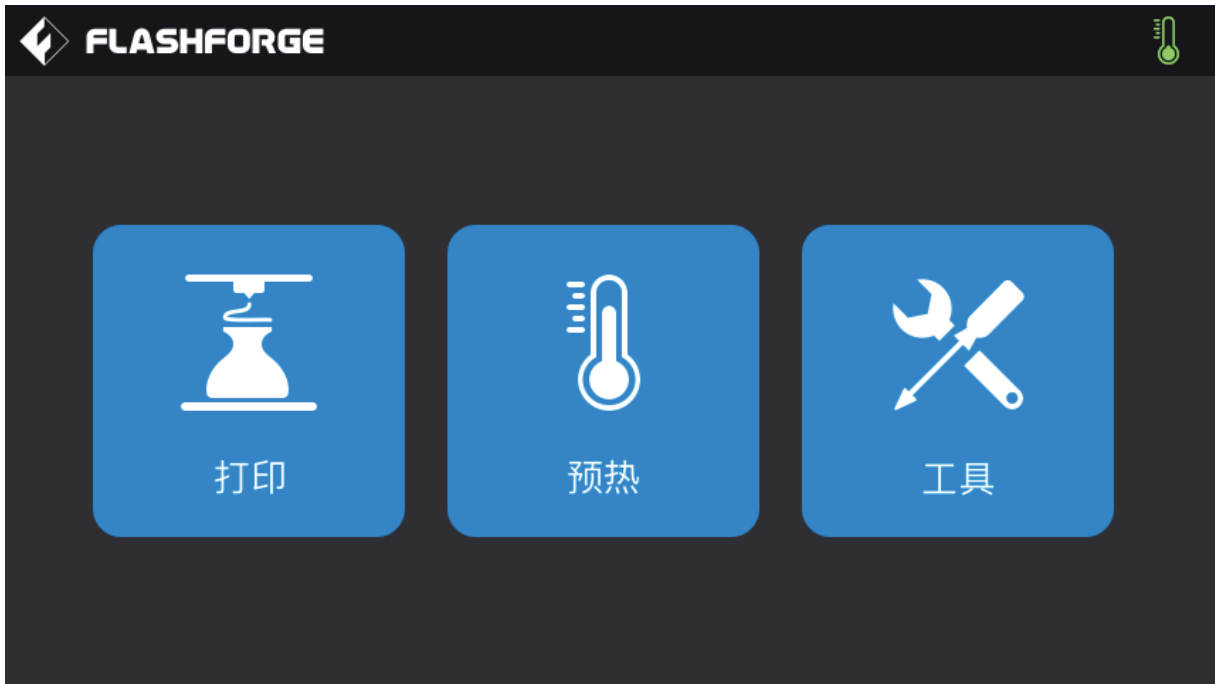

点击【预热】，进入预热界面。



### 预热界面

- 1、开/关：打开左右喷头/加热平台预热功能，关闭左右喷头/加热平台预热功能；
- 2、温度数值：点击温度数值前后的“-”“+”可进行预热温度设定；
- 3、开始：点击开始图标，喷头或加热平台开始预热；



### 喷头/加热平台加热界面显示有

- 1、实际温度值；
- 2、目标温度值；
- 3、停止：可暂停预热；

## 5.3 工具

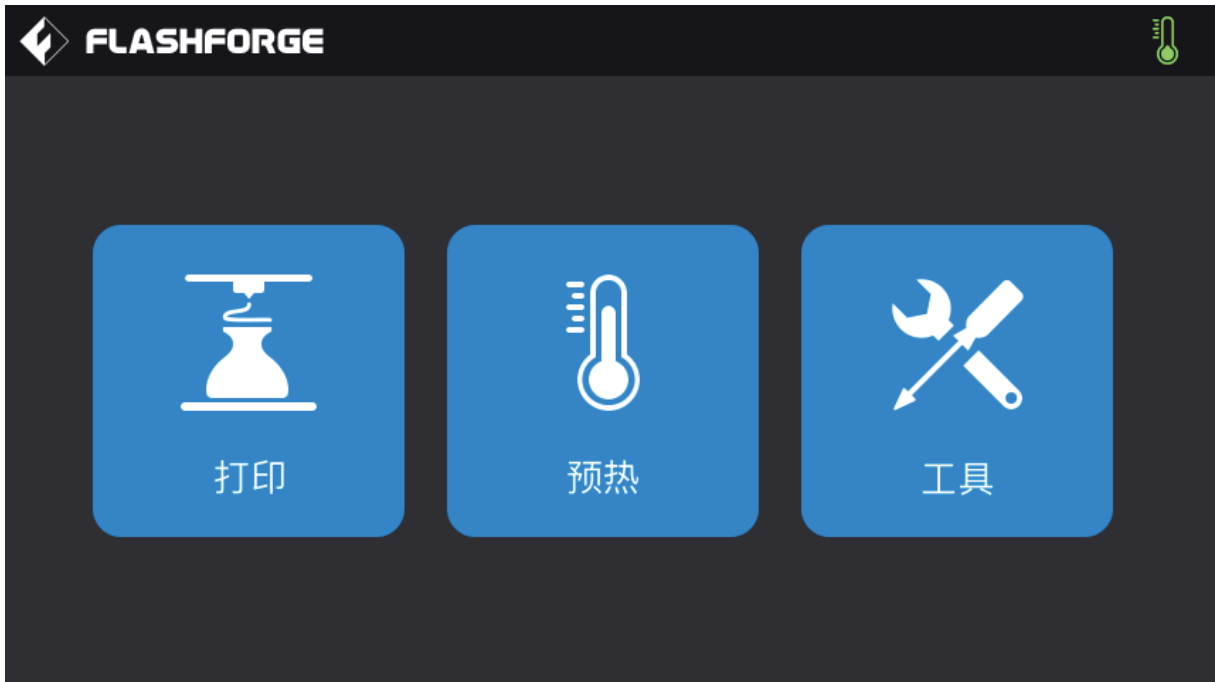

点击【工具】，进入工具设置界面。



工具界面显示有

- 1、换丝：进行进/退丝操作；
- 2、调平：调节打印平台；
- 3、回零：使打印机X/Y/Z轴回到机械原点；
- 4、手动调节：手动调节X/Y/Z轴的位置；
- 5、设置：对打印机进行相关的功能设置；
- 6、状态：查看打印机的实时状态；
- 7、关于：查看打印机的版本信息等；



【工具】-【换丝】

进丝/退丝界面显示有

- 1、进丝操作；
- 2、退丝操作；
- 3、左喷头进丝开关；
- 4、右喷头进丝开关；
- 5、左喷头退丝开关；
- 6、右喷头退丝开关；
- 7、开始：点击开始图标，进丝或退丝开始；





进丝/退丝执行界面显示有

- a、实际温度值；
- b、目标温度值；
- c、取消：可取消预热；
- d、完成：按照界面说明操作；



**【工具】 - 【调平】**

轻点此选项，开始打印平台的调平程序（若要详细了解打印平台调平说明，请参见第【61】页）。触摸屏将显示指示信息，告知您如何调平平台。



**【工具】 - 【回零】**

轻点此选项，让喷头和打印平台返回至初始位置。



### 【工具】-【手动调节】

点击手动调节图标，进入手动调节模式

- 1、Y+：喷头往Y轴正方向移动，即向后；
- 2、Y-：喷头往Y轴负方向移动，即向前；
- 3、X- 左喷头往X轴正方向移动，即向左；
- 4、X+ 左喷头往X轴负方向移动，即向右；
- 5、X- 右喷头往X轴正方向移动，即向左；
- 6、X+ 右喷头往X轴负方向移动，即向右；
- 7、Z- 平台向上移动；
- 8、Z+ 平台向下移动；

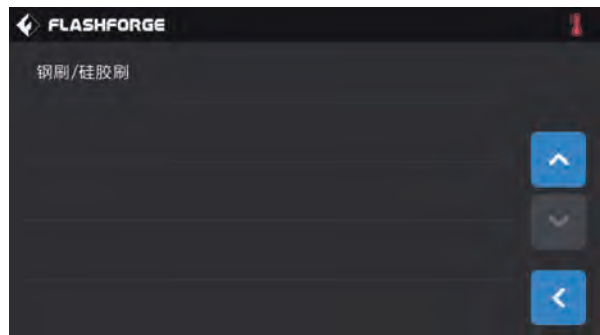
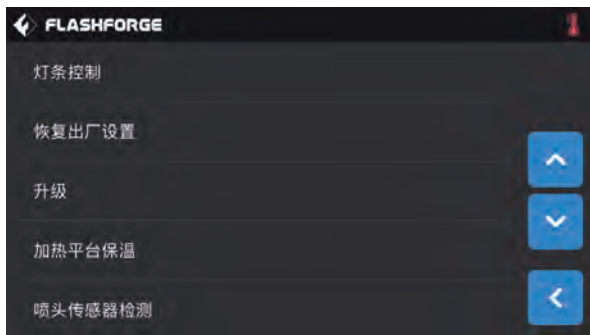
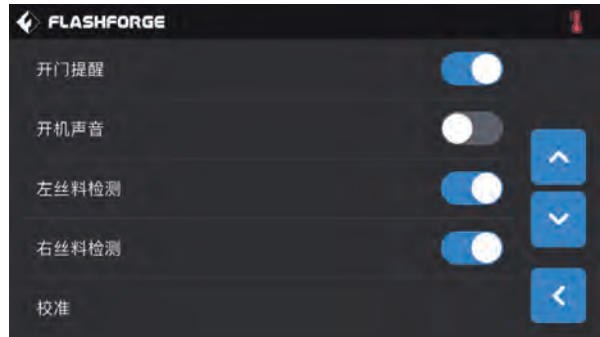
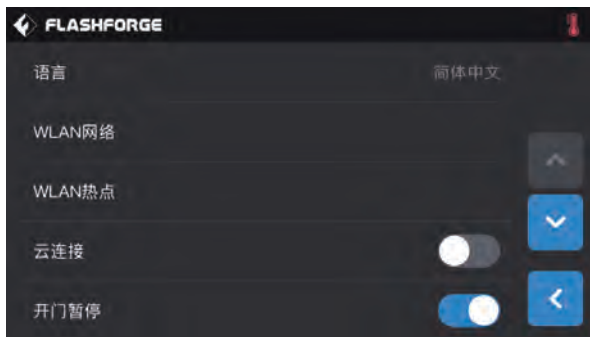

### 【工具】-【设置】

点击设置图标，进入设置界面

- 1、语言：设置打印机显示语言；
- 2、WLAN网络：关闭/开启网络连接；
- 3、WLAN热点：关闭/开启WiFi热点；
- 4、云连接：关闭/开启云连接下载打印功能；
- 5、开门暂停：关闭/开启开门暂停；
- 6、开门提醒：关闭/开启开门提醒；
- 7、开机声音：打开/关闭机器开机声音；
- 8、左丝盘检测：打开/关闭左丝料检测功能；
- 9、右丝盘检测：打开/关闭右丝料检测功能；
- 10、校准：对Z、X、Y三轴坐标校准；

- 11、灯条控制：打开/关闭机器内部灯条；
- 12、恢复出厂设置：回到出厂时的设置；
- 13、升级：预留更新功能；
- 14、加热平台保温：打印完成平台仍处于保温；
- 15、喷头传感器检测：检测喷头传感器是否异常；
- 16、钢刷/硅胶刷：选择擦嘴装置为钢刷/硅胶刷；

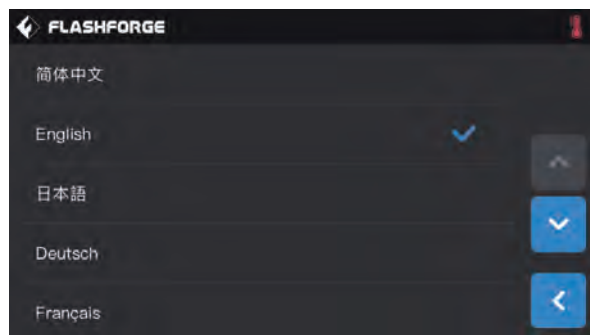
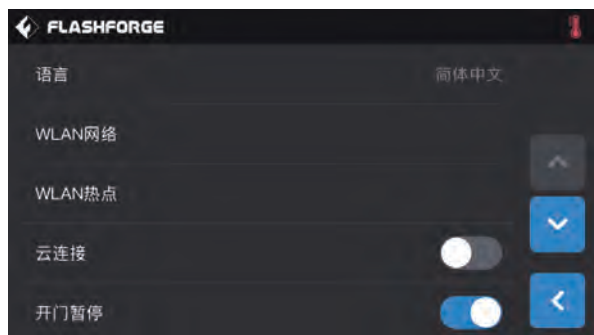

#### 【设置】-【语言】

点击语言图标，进入语言设置界面

- 1、所选语言种类：选中需要的语言即完成设备操作语言切换；
- 2、翻页：翻到上/下页菜单；

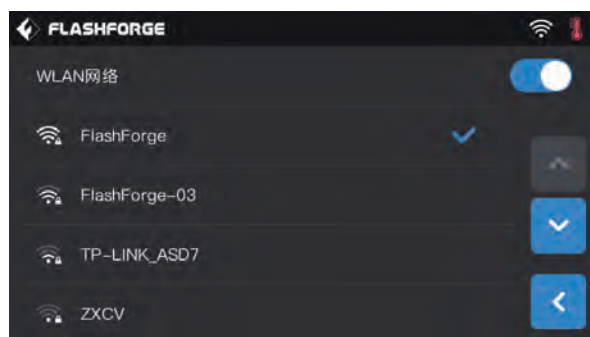
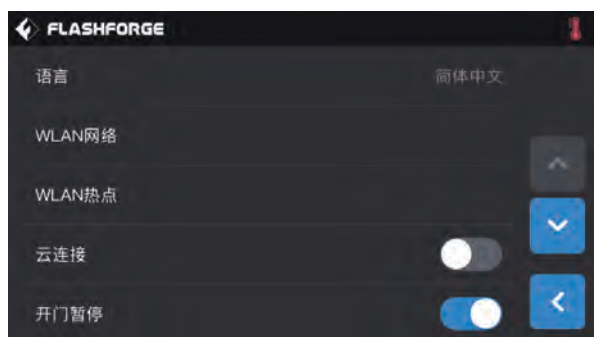

#### 【设置】-【WLAN网络】

打开WLAN功能，设备可以连接到局域无线网，可实现：

- ① 远距离的文件传输和打印，具体介绍，参见【77】页网络传输打印。
- ② 远程监控设备打印状态，具体介绍，参见【82】页WLAN网络连接摄像头。

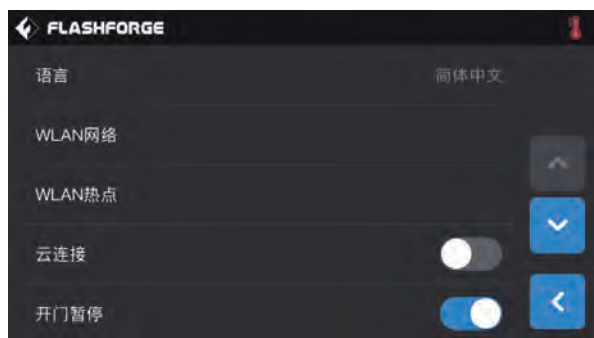

#### 【设置】-【WLAN热点】

打开WLAN热点功能，实现设备和电脑的热点连接，可实现：

- ① 远距离的文件传输和打印，具体介绍，参见【78】页热点连接打印。
- ② 远程监控设备打印状态，具体介绍，参见【81】页WLAN热点连接摄像头。

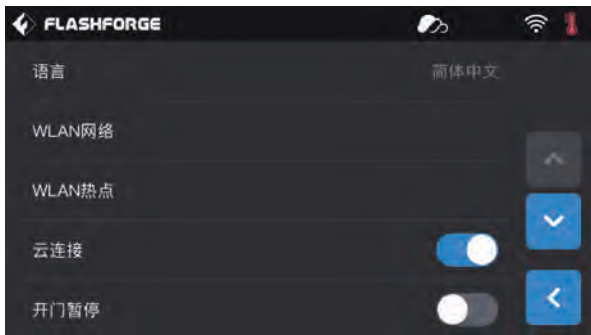

**【设置】-【云连接】**

通过云连接，可以突破局域网的限制，可实现：

- ① 远距离的文件传输和打印，具体介绍，参见【78】页闪铸云打印。
- ② 远程监控设备打印状态，具体介绍，参见【82】页闪铸云连接摄像头。

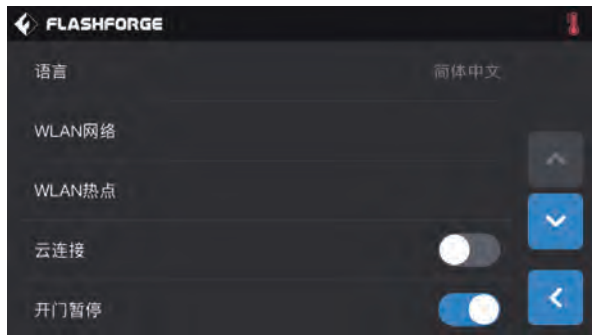

**【设置】-【开门暂停】**

开启“开门暂停”功能，在设备打印过程中，开启前门，打印将暂停。

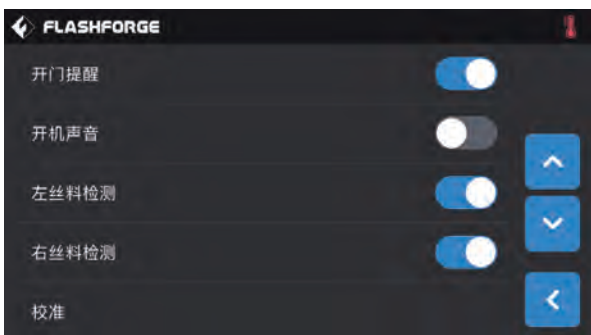

**【设置】-【开门提醒】**

开启“开门提醒”功能，在设备打印过程中，开启前门，触摸屏将出现提示语。

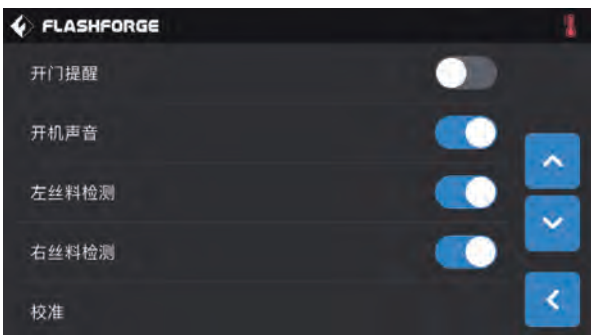

**【设置】-【开机声音】**

您可以打开或关闭开机声音提醒功能。

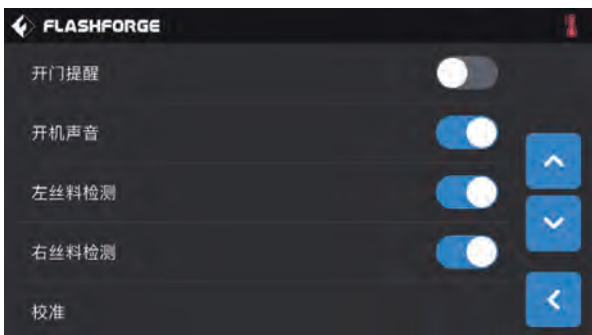

**【设置】-【左/右丝料检测】**

您可以打开或关闭左右丝料检测功能。此功能开启后，若耗材用尽或中断时，将被检测到。若需要选择使用外置耗材，请关闭该功能，以正常打印。

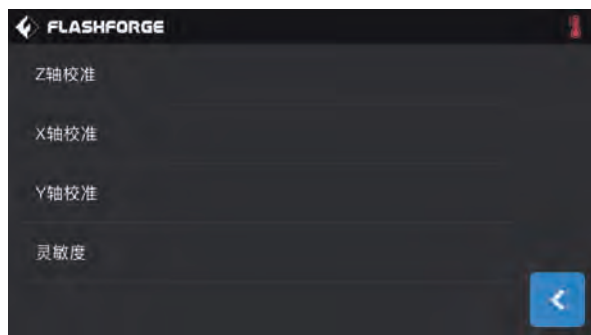
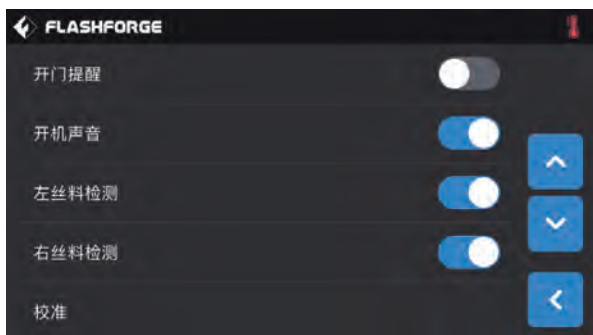

### 【设置】-【校准】

校准分为Z轴校准、Y轴校准和X轴校准。具体操作，请参见【68】页。

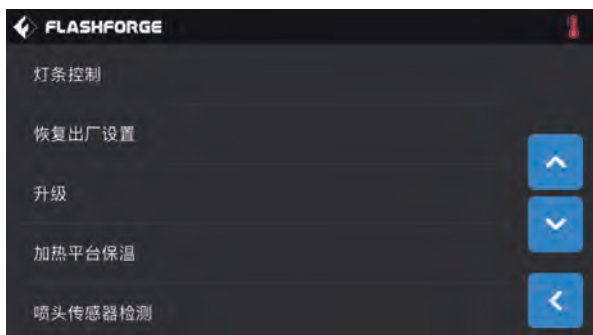

### 【设置】-【灯条控制】

您可以开启或关闭照明 / 背光灯条；其中灯光的亮度都可以根据您的需要进行调节。

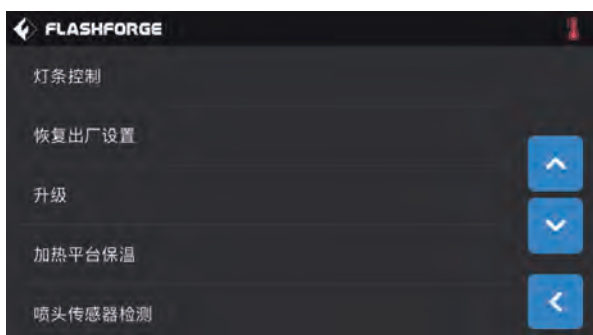

### 【设置】-【恢复出厂设置】

开启该功能，设备状态恢复到出厂时的技术状态。

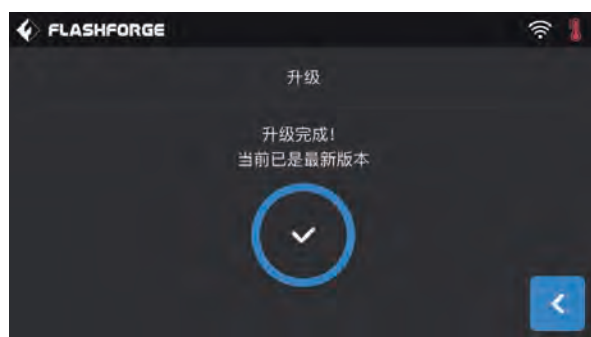
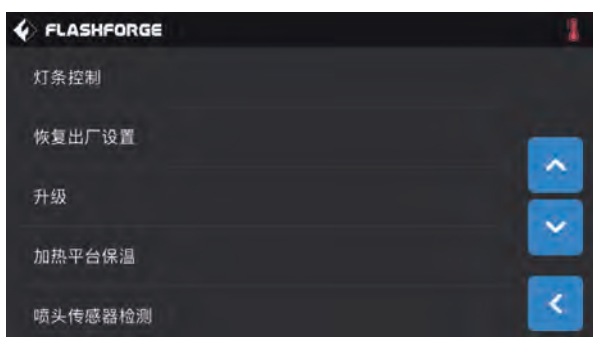

### 【设置】-【升级】

在设备连接到局域网的情况下，轻点【升级】，若检测到设备有待升级固件，设备可以自动更新至最新固件。升级完成后，重启设备。

注意！设备升级过程中，不要切断电源和网络，以避免打印失败。

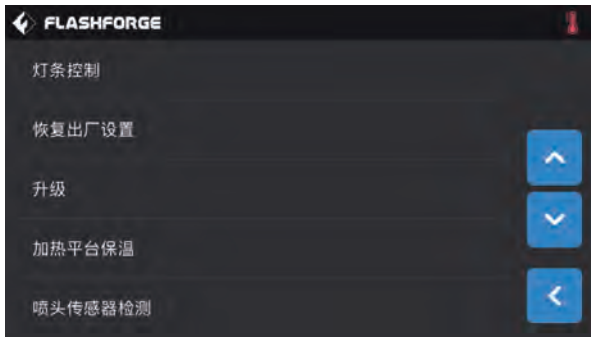

**【设置】-【加热平台保温】**

可设置平台保温时长1-10分钟，当打印结束后，平台将会保温当前设置的时长。减少第二个模型打印的加温时长。

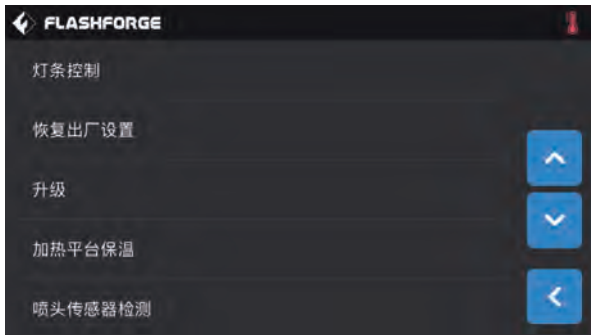

**【设置】-【喷头传感器检测】**

使用喷头传感器检测功能可检测传感器是否异常；如无法触发，请调整传感器的灵敏度后再次尝试；若仍然无法触发，则说明传感器已损坏。

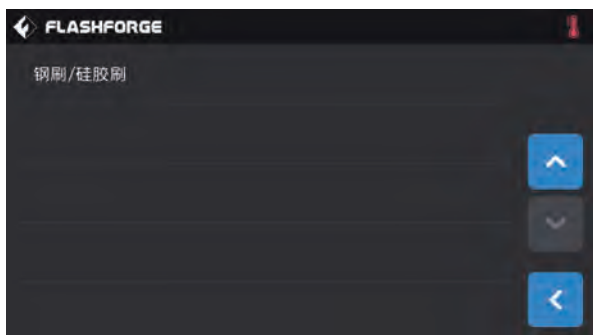

### 【设置】-【钢刷/硅胶刷】

设备支持两种刷除废料装置：

- 钢刷Y方向刷；
- 硅胶刷X方向刷；切换喷头时将会预吐一段丝料，以避免由于漏丝引起的模型缺丝；新出厂设备均为硅胶刷。

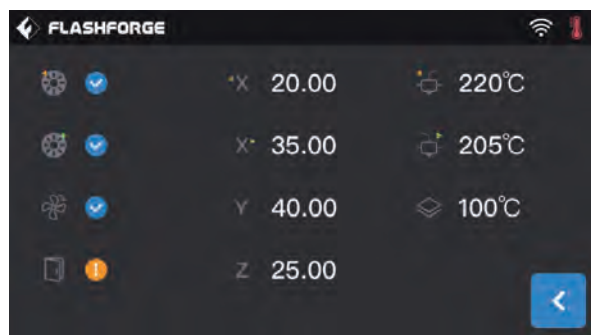

### 【工具】-【状态】

查看左/右喷头温度、加热平台温度，丝盘装载、开门暂停、风扇状态及左/右喷头X, Y, Z轴当前位置。

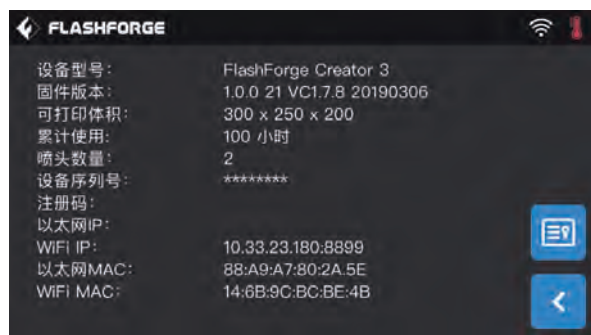

### 【工具】-【关于】



显示设备基本信息，信息详情以设备实际显示为准。其中云平台注册码、以太网IP、WiFi IP都在【关于】中查看。

说明：在申请售后服务时，需将【关于】中的设备序列号提供给售后工程师。

# 6. 维护

## 6.1 拷贝日志



- 1、插入U盘，在设备的触摸屏右上角会出现  图标。
- 2、点击  图标，等待10秒，拔掉U盘。
- 3、把U盘插入电脑，打开U盘文件夹找到 log文件。
- 4、请把日志文件发给闪铸客服。

## 6.2 维护与检修

问题	原因	改正措施
喷头偏离中心。	设备以遗失喷头的精确位置轨迹无法正确打印。	取下模型，清理干净打印平台，将喷头送回原始位置，重新校准。再打印新的模型。
耗材未能正确挤出或粘附在打印平台上。	可能是打印平台未调平，与喷头间距不一致。	重新调平。
模型开始打印之前设备无响应。	设备可能接收到了相互矛盾的命令。	关闭电源开关，等待30秒，然后打开电源开关。
打印结束时，耗材成块附着在喷嘴上；或耗材呈丝状散落在打印机内。	模型某层未能正确粘附，保存模型时采用了接触打印平台的最小表面积；或模型打印时未选择支撑，悬浮于打印平台上方。	重新对模型进行切片，如有必要增加支撑。
模型只打印了一半。	打印耗材耗尽。 打印期间喷头堵头。	更换打印哈耗材，开启丝料检测功能，继续打印；参见下面的“打印耗材无法挤出”。
打印耗材无法挤出。	喷头堵头。	使用通针在进丝状态下推动耗材。 联系客服。
喷头无法回到原位。	限位开关线路故障。	联系客服。
在陡峭的突出部分，模型表面呈细长稀疏或有磨损。	模型突出太远或太抖（小于45度角）。	使用支撑打印。



## 6.3 疏通喷嘴

- 1、点击【预热】，设置加温温度，轻点返回键。
- 2、点击【工具】-【换丝】-目标喷头【进丝】，等待喷头加热升温至屏幕提示进丝，将通针插入喷头入口（顶部）。
- 3、将阻塞的残渣推下去，并从喷嘴挤出。若遇到一定阻力，可以向下用力。注意，不要使用蛮力，若尝试几次，用力疏通无果，需要更换喷嘴或联系售后客服。

## 6.4 日常保养及使用建议

- 1、日常不使用设备期间，请盖上顶盖，关闭前门，避免设备落灰。长期未使用者，建议使用原厂包装封存。
- 2、定期给运动部件上润滑油（脂）。使用频繁者，至少每三个月添加一次润滑油（脂）；长期不使用者，至少每半年添加一次润滑油（脂）。
- 3、每次打印结束，请及时清理打印内腔的耗材残渣和其他杂物，避免细小杂物掉入底部电路板中，影响设备使用。
- 4、打印贴纸为消耗品，当打印平台贴纸附着力下降，甚至破损；请及时更换打印贴纸。以免影响打印效果。
- 5、首次使用设备或更换打印耗材后，应使用闪铸官方耗材，直到喷嘴挤出耗材与装入耗材颜色一致。
- 6、无论何时，建议将模型至于打印平台的中心位置。可以在切片软件中设置模型摆放位置。
- 7、对于陡峭的凸出部分（小于45度角），建议使用支撑打印。

## 7. 帮助与支持

闪铸专业的售后服务人员及业务员随时为您待命，非常乐意为您解决在你使用过程中遇到的任何问题。如果你的问题从用户手册中找不到答案，你可以进入我们的官方网站来搜索问题的解决方案，当然您也可以通过电话或QQ联系我们。

在我们的官网中可以找到一些常见问题的说明和解决方法。您的许多问题都可以在闪铸科技官方网站 [www.sz3dp.com](http://www.sz3dp.com) 得到解决。

您可以在周一到周六的上午8:00到下午5:00的时间段通过电话和QQ来联系闪铸的售后团队，为您解决问题。如果您刚好在下班时间联系我们，我们将在下一个工作日的第一时间给您反馈，为您解决问题，若造成不便，我们万分抱歉。

提示：由于更换不同的丝料，会有少量杂质残留在喷头中造成喷头堵塞，疏通后即可，不属于质量问题，不在400小时寿命范围内，若用户使用时存在该问题，请联系售后，并在售后的指导下完成疏通工作。

售后服务热线：400-886-6023

售后QQ：2850862986 / 2850863000 / 2853382161

邮箱：[flashforge@flashforge.zohodesk.com](mailto:flashforge@flashforge.zohodesk.com) / [support@flashforge.zohodesk.com](mailto:support@flashforge.zohodesk.com)

3D爱好者QQ群：206773820

公司地址：浙江省金华市婺城区仙源路518号

提示：联系售后时，请提供产品序列号，也就是打印机背部的条形码。







YouTube



优酷自频道

Scan QR to Get More  
After-Sales Support  
扫描二维码获得更多售后支持



浙江闪铸三维科技有限公司  
FLASHFORGE CORPORATION

售后专线: [support@ff3dp.com](mailto:support@ff3dp.com)

服务热线: 400-886-6023

官方网站: [www.sz3dp.com](http://www.sz3dp.com)

公司地址: 浙江省金华市婺城区仙源路518号